

Thermal Overload Relays

Electronic Overload Relays





Thermal overload relays T... Electronic overload relays E...

Contents

Thermal/electronic overload relays

Overview	4
Motor protection	6

Thermal overload relays

Odering details T, TA	7
Accessories	12

Electronic overload relays E 16 DU

Odering details	14
-----------------------	----

Electronic overload relays E 200/320/500/800 DU

Odering details	15
-----------------------	----

Thermal overload relays T...

Description	17
Technical data	18
Tripping curves	24

Electronic overload relays E 16 DU

Technical data	28
----------------------	----

Thermal/electronic overload relays and Accessories

Dimension diagrams	32
--------------------------	----

Thermal/electronic overload relays

Overview

Thermal/electronic
overload relays

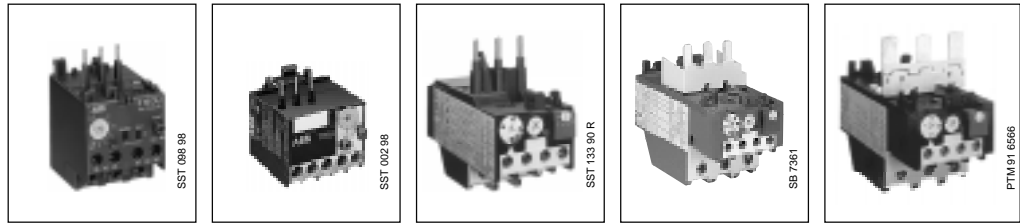

Type

E 16 DU

T 7 DU

TA 25 DU

TA 42 DU

TA 75 DU

Description

Design

Three-pole, with temperature compensation and phase-failure protection
1 NO + 1 NC built-in auxiliary contacts

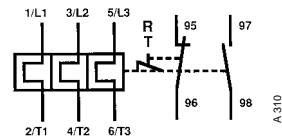

Resetting

Convertible Manual/Automatic

Setting ranges

Number

5

11

18

3

6

from
to

0.1 ... **0.32 A**
5.7 ... **18.9 A**

0.1 ... **0.16 A**
9.0 ... **12.0 A**

0.1 ... **0.16 A**
24 ... **32 A**

18 ... **25 A**
29 ... **42 A**

18 ... **25 A**
60 ... **80 A**

Mounting possibilities onto contactors

Mounting kits

No mounting kit required, direct mounting

Mounting onto contactor

**B 6, BC 6, VB 6,
VB 6A, VBC 6,
VBC 6A, B 7,
BC 7, VB 7, VB 7A,
VBC 7, VBC 7A
A 9, A 12, A 16**

**B 6, BC 6, VB 6,
B 6A, VBC 6,
VBC 6A
B 7, BC 7, VB 7,
VB 7A, VBC 7,
VBC 7A**

**A 9 ... A 40
BC 9 ... BC 30**

**A 30, A 40
BC 30**

**A 50 ... A 75
AE 50 ... AE 75**

Mounting kits for single set-ups

Mounting kit			DB 25	DB 80	DB 80
--------------	--	--	--------------	--------------	--------------

Accessories



Remote tripping coil			DS 25-A		
Remote reset coil			DR 25-A		
Main terminal shroud	Terminal shroud integrated				
Identification marker	BA 5-50				

Thermal/electronic overload relays for special application

For motors with heavy starting	E16 DU ... 20/30				
For EEx e motor protection	on request	T 7 DU	TA 25 DU ... V 1000	TA 42 DU ... V 1000	TA 75 DU ... V 1000

Thermal/electronic overload relays

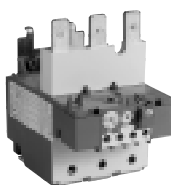
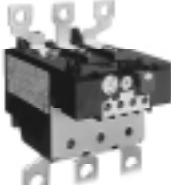
Overview

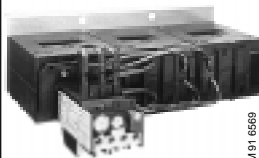
 PTM 91 6565	 SB 7398	 PTM 91 6571	 PTM 91 6570	 PTM 91 6569
TA 80 DU	TA 110 DU	T / TA 200 DU	T / TA 450 DU/SU	T 900 DU/SU

Three-pole, with temperature compensation and phase-failure protection
1 NO + 1 NC build-in auxiliary contacts

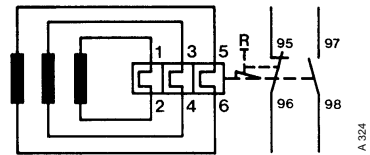
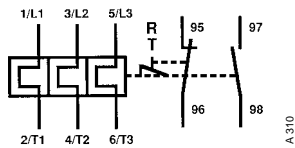

Convertible Manual/Automatic

4	1	5	4	4
29 ... 42 A 60 ... 80 A	65 ... 90 A 80 ... 110 A	80 ... 110 A 150 ... 200 A	DU 130 ... 185 A 285 ... 400 A	SU 40 ... 60 A 285 ... 400 A
				265 ... 375 A 610 ... 850 A

Mounting possibilities onto contactors

No mounting kits required, direct mounting		AT 450/EH.../ DT 450/A	AT 900/EH ... <small>See Accessories, Page ?? and ??</small>
A 95, A 110 AE 95, AE 110			
	A 95, A 110 AE 95, AE 110		
		T for EH 145 EH 175 EH 210 TA for A 145, A 185	
		T for EH175+AT450/EH160 EH 210 + AT 450/EH 160 EH 260 + AT 450/EH 300 EH 300 + AT 450/EH 300 EH 370 + AT 450/EH 370 TA for A 210 A 260 A 300	
			EH 370+AT 900/EH 370/550 EH 550 + AT 900/EH 550 EH 700 + AT 900/EH 700 EH 800 + AT 900/EH 800

Mounting kits for single set-ups

DB 80	DB 200	No mounting kits required	
		DS 25-A	DS 25-A
		DR 25-A	DR 25-A
Terminal shroud integrated	LT 200 / LT 200 A	LT 450 -.	LT 900 -.
	BA 5-50		
		T 450 SU	T 900 SU
TA 80 DU ... V 1000	TA 110 DU ... V 1000	T/TA 200 DU ... V 1000	T/TA 450 DU/SU ... V 1000
			T 900 DU/SU ... V 1000

Motor protection

Selection of the protection device

Motor protection - General aspects

Selection of an adequate motor protection is of great importance with regard to the operational reliability and service life of a motor. The effectiveness of the available motor protection devices depends on the range of application. The following shows a summary which facilitates the correct choice. Since no general rules exist, we will gladly give you further advice in special cases such as heavy starting.

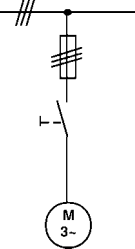
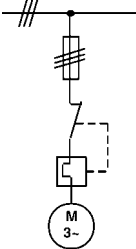
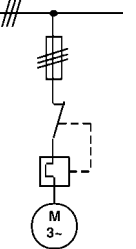
Efficiency	Protection device current-dependent: Fuses	Overload relays with protection device in case of phase failure	Protection device, temperature-dependent: Thermistor machine protection CUSTORAPID®
Reasons for unwanted overloading of the motor winding	 SST 081 91 M 2	 SST 081 91 M 1	 SST 081 91 M 3
1 Current overloading	<input type="checkbox"/>		
2 Rated duty types S1-S8 to IEC 34-1	<input type="checkbox"/>	<input checked="" type="checkbox"/>	<input checked="" type="checkbox"/>
3 Operation when starting, braking, reversing	<input type="checkbox"/>	<input checked="" type="checkbox"/>	<input checked="" type="checkbox"/>
4 Operation at starting rates Schalthäufigkeit 15 ops./h	<input type="checkbox"/>	<input checked="" type="checkbox"/>	<input checked="" type="checkbox"/>
5 Locked motor	<input checked="" type="checkbox"/>	<input checked="" type="checkbox"/>	<input checked="" type="checkbox"/> In the case of motors with thermally critical rotor
6 Overload at phase failure	<input type="checkbox"/>	<input checked="" type="checkbox"/>	<input checked="" type="checkbox"/>
7 Over-/undervoltage in supply mains	<input type="checkbox"/>	<input checked="" type="checkbox"/>	<input checked="" type="checkbox"/>
8 Variation of frequency in supply mains	<input type="checkbox"/>	<input checked="" type="checkbox"/>	<input checked="" type="checkbox"/>
9 Increased ambient temperature	<input type="checkbox"/>	<input checked="" type="checkbox"/>	<input checked="" type="checkbox"/>
10 External heating of the motor (e.g.: bearing heating)	<input type="checkbox"/>	<input type="checkbox"/>	<input checked="" type="checkbox"/>
11 Obstruction to motor cooling	<input type="checkbox"/>	<input type="checkbox"/>	<input checked="" type="checkbox"/>

Efficiency of protection device: not effective
 partly effective
 fully effective

Note on fuses

Fuses do not protect a motor against overload. They serve only as short-circuit protection of switchgear and cables. For direct starting, fuses of around 1.5 to 2.5 times the rated current should be used. A fuse must withstand 1.3 times its rated current for a sustained period. This would entail thermal overload of the motor. In order to protect motors against short-circuits, it is advisable to use fuses aM in conjunction with the thermal overload relay. The specifications in relation to short-circuit protection for contactors and overload relays must be noted when selecting the rating of fuses or circuit-breakers.

Thermal overload relay T 7 DU

Ordering details



Type	Order code	Setting range	Max.fuse		Price / piece	Packing unit	Weight / piece
			See page 22 aMg	L/gG			
		A ... A	A	A		piece	kg

T7 DU Thermal overload relays

for mini contactors B 6, BC 6, B 6S, BC 6, VB 6, VBC 6, B 7, BC 7, B 7S, BC 7, VB 7, VBC 7,

T 7 DU 0.16	1SAZ 111 301 R 0001	0.1 ... 0.16		0.5		1	0.070
T 7 DU 0.24	1SAZ 111 301 R 0002	0.16 ... 0.24		1		1	0.070
T 7 DU 0.4	1SAZ 111 301 R 0003	0.24 ... 0.4		2		1	0.070
T 7 DU 0.6	1SAZ 111 301 R 0004	0.4 ... 0.6		2		1	0.070
T 7 DU 1.0	1SAZ 111 301 R 0005	0.6 ... 1.0		4		1	0.070
T 7 DU 1.6	1SAZ 111 301 R 0006	1.0 ... 1.6		6		1	0.070
T 7 DU 2.4	1SAZ 111 301 R 0007	1.6 ... 2.4		6		1	0.070
T 7 DU 4.0	1SAZ 111 301 R 0008	2.4 ... 4.0		10		1	0.070
T 7 DU 6.0	1SAZ 111 301 R 0009	4.0 ... 6.0		10		1	0.070
T 7 DU 9.0	1SAZ 111 301 R 0010	6.0 ... 9.0		10		1	0.070
T 7 DU12.0	1SAZ 111 301 R 0011	9.0 ... 12.0		20		1	0.070

Thermal overload relays

TA25 DU, TA25 DU... V 1000, TA42 DU, TA42 DU... V 1000

Ordering details

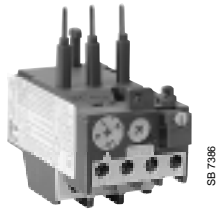

TA 25 DU

SB 7386

Type	Order code	Setting range		Max.fuse		Price / piece	Pack- ing unit piece	Weight per piece kg
		A	... A	See page 20 aM A	gL/gG A			
TA 25 DU for contactors A 9 ... A 40 and BC 9 ... BC 30								
TA 25 DU 0.16	1SAZ 21 1201 R1005	0.1	... 0.16	-	0.5		1	0.150
TA 25 DU 0.25	1SAZ 21 1201 R1009	0.16	... 0.25	-	0.63		1	0.150
TA 25 DU 0.4	1SAZ 21 1201 R1013	0.25	... 0.4	-	1.25		1	0.150
TA 25 DU 0.63	1SAZ 21 1201 R1017	0.4	... 0.63	-	2		1	0.150
TA 25 DU 1.0	1SAZ 21 1201 R1021	0.63	... 1.0	2	4		1	0.150
TA 25 DU 1.4	1SAZ 21 1201 R1023	1.0	... 1.4	2	4		1	0.150
TA 25 DU 1.8	1SAZ 21 1201 R1025	1.3	... 1.8	4	6		1	0.150
TA 25 DU 2.4	1SAZ 21 1201 R1028	1.7	... 2.4	4	6		1	0.150
TA 25 DU 3.1	1SAZ 21 1201 R1031	2.2	... 3.1	6	10		1	0.150
TA 25 DU 4.0	1SAZ 21 1201 R1033	2.8	... 4.0	6	10		1	0.150
TA 25 DU 5.0	1SAZ 21 1201 R1035	3.5	... 5.0	10	16		1	0.150
TA 25 DU 6.5	1SAZ 21 1201 R1038	4.5	... 6.5	16	20		1	0.150
TA 25 DU 8.5	1SAZ 21 1201 R1040	6.0	... 8.5	20	25		1	0.150
TA 25 DU 11	1SAZ 21 1201 R1043	7.5	... 11	25	35		1	0.150
TA 25 DU 14	1SAZ 21 1201 R1045	10	... 14	25	35		1	0.150
TA 25 DU 19	1SAZ 21 1201 R1047	13	... 19	35	50		1	0.150
TA 25 DU 25	1SAZ 21 1201 R1051	18	... 25	50	63		1	0.150
TA 25 DU 32	1SAZ 21 1201 R1053	24	... 32 (1)	63	80		1	0.170

(1) With terminal block DX 25: 1 x 16 mm2

TA 25 DU ... V 1000 (EEEx e) for contactors A 9 ... A 40, BC 9 ... BC 30								
TA 25 DU 0.16	V1000 1SAZ 21 1301 R1005	0.1	... 0.16	-	0.50		1	0.150
TA 25 DU 0.25	V1000 1SAZ 21 1301 R1009	0.16	... 0.25	-	0.63		1	0.150
TA 25 DU 0.4	V1000 1SAZ 21 1301 R1013	0.25	... 0.4	-	1.25		1	0.150
TA 25 DU 0.63	V1000 1SAZ 21 1301 R1017	0.4	... 0.63	-	2		1	0.150
TA 25 DU 1.0	V1000 1SAZ 21 1301 R1021	0.63	... 1.0	2	4		1	0.150
TA 25 DU 1.4	V1000 1SAZ 21 1301 R1023	1.0	... 1.4	2	4		1	0.150
TA 25 DU 1.8	V1000 1SAZ 21 1301 R1025	1.3	... 1.8	4	6		1	0.150
TA 25 DU 2.4	V1000 1SAZ 21 1301 R1028	1.7	... 2.4	4	6		1	0.150
TA 25 DU 3.1	V1000 1SAZ 21 1301 R1031	2.2	... 3.1	6	10		1	0.150
TA 25 DU 4.0	V1000 1SAZ 21 1301 R1033	2.8	... 4.0	6	10		1	0.150
TA 25 DU 5.0	V1000 1SAZ 21 1301 R1035	3.5	... 5.0	10	16		1	0.150
TA 25 DU 6.5	V1000 1SAZ 21 1301 R1038	4.5	... 6.5	16	20		1	0.150
TA 25 DU 8.5	V1000 1SAZ 21 1301 R1040	6.0	... 8.5	20	25		1	0.150
TA 25 DU 11	V1000 1SAZ 21 1301 R1043	7.5	... 11.0	25	35		1	0.150
TA 25 DU 14	V1000 1SAZ 21 1301 R1045	10	... 14	25	35		1	0.150
TA 25 DU 19	V1000 1SAZ 21 1301 R1047	13	... 19	35	50		1	0.150
TA 25 DU 25	V1000 1SAZ 21 1301 R1051	18	... 25	50	63		1	0.150
TA 25 DU 32	V1000 1SAZ 21 1301 R1053	24	... 32 (1)	63	80		1	0.170

(1) With terminal block DX 25: 1 x 16 mm2

TA 42 DU for contactors A 30, A 40 and BC 30								
TA 42 DU 25	1SAZ 31 1201 R1001	18	... 25	50	63		1	0.330
TA 42 DU 32	1SAZ 31 1201 R1002	22	... 32	63	80		1	0.330
TA 42 DU 42	1SAZ 31 1201 R1003	29	... 42	80	100		1	0.330

TA 42 DU ... V1000 (EEEx e) for contactors A 30, A 40 and BC 30								
TA 42 DU 25	V1000 1SAZ 31 1301 R1001	18	... 25	50	63		1	0.330
TA 42 DU 32	V1000 1SAZ 31 1301 R1002	22	... 32	63	80		1	0.330
TA 42 DU 42	V1000 1SAZ 31 1301 R1003	29	... 42	80	100		1	0.330

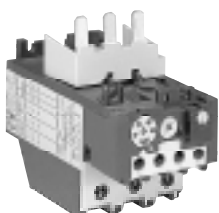

TA 42 DU

SB 7361

Thermal overload relays

TA 75 DU, TA 80 DU, TA 110 DU, TA 200 DU

Ordering details

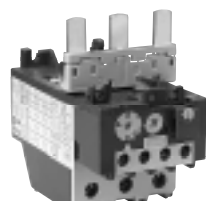

TA 75 DU

SB 7387

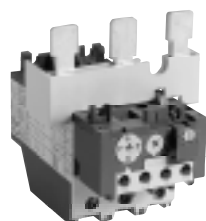

TA 80 DU

SB 7389

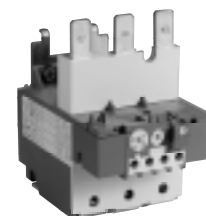

TA 110 DU

SB 7386



TA 200 DU

SST02 89

Type	Order code	Setting range	Max.fuse See page 21 aM gL/gG A A	Price / piece	Pack- ing unit piece	Weight / piece kg
	A ... A					

TA 75 DU for contactors A 50 ... A 75 and AE 50 ... AE 75

TA 75 DU 25	1SAZ 32 1201 R1001	18 ... 25	50 63		1	0.330
TA 75 DU 32	1SAZ 32 1201 R1002	22 ... 32	63 80		1	0.330
TA 75 DU 42	1SAZ 32 1201 R1003	29 ... 42	80 100		1	0.330
TA 75 DU 52	1SAZ 32 1201 R1004	36 ... 52	100 125		1	0.330
TA 75 DU 63	1SAZ 32 1201 R1005	45 ... 63	125 160		1	0.330
TA 75 DU 80	1SAZ 32 1201 R1006	60 ... 80	160 200		1	0.330

TA 75 DU ... V 1000 (EEx e) for contactors A 50 ... A 75 and AE 50 ... AE 75

TA 75 DU 25	V 1000 1SAZ 32 1301 R1001	18 ... 25	50 63		1	0.330
TA 75 DU 32	V 1000 1SAZ 32 1301 R1002	22 ... 32	63 80		1	0.330
TA 75 DU 42	V 1000 1SAZ 32 1301 R1003	29 ... 42	80 100		1	0.330
TA 75 DU 52	V 1000 1SAZ 32 1301 R1004	36 ... 52	100 125		1	0.330
TA 75 DU 63	V 1000 1SAZ 32 1301 R1005	45 ... 63	125 160		1	0.330
TA 75 DU 80	V 1000 1SAZ 32 1301 R1006	60 ... 80	160 200		1	0.330

TA 80 DU for contactors A 95, A 110, AE 95 and AE 110

TA 80 DU 42	1SAZ 33 1201 R1003	29 ... 42	80 100		1	0.360
TA 80 DU 52	1SAZ 33 1201 R1004	36 ... 52	100 125		1	0.360
TA 80 DU 63	1SAZ 33 1201 R1005	45 ... 63	125 160		1	0.360
TA 80 DU 80	1SAZ 33 1201 R1006	60 ... 80	160 200		1	0.360

TA 80 DU ... V 1000 (EEx e) for contactors A 95, A 110, AE 95 and AE 110

TA 80 DU 42	V 1000 1SAZ 33 1301 R1003	29 ... 42	80 100		1	0.360
TA 80 DU 52	V 1000 1SAZ 33 1301 R1004	36 ... 52	100 125		1	0.360
TA 80 DU 63	V 1000 1SAZ 33 1301 R1005	45 ... 63	125 160		1	0.360
TA 80 DU 80	V 1000 1SAZ 33 1301 R1006	60 ... 80	160 200		1	0.360

TA 110 DU for contactors A 95, A 110, AE 95 and AE 110

TA 110 DU 90	1SAZ 41 1201 R1001	65 ... 90	160 200		1	0.750
TA 110 DU 110	1SAZ 41 1201 R1002	80 ... 110	200 224		1	0.750

TA 110 DU ... V 1000 (EEx e) for contactors A 95, A 110, AE 95 and AE 110

TA 110 DU 90	V 1000 1SAZ 41 1301 R1001	65 ... 90	160 200		1	0.750
TA 110 DU 110	V 1000 1SAZ 41 1301 R1002	80 ... 110	200 224		1	0.750

Type	Order code	Setting range	For contactor	Price / piece	Pack- ing unit piece	Weight / piece kg
		A. .. A				

Normal starting time class 10 A

TA 200 DU 90	1SAZ 421 201 R1001	66 ... 90	A 145, 185			0.750
TA 200 DU 110	1SAZ 421 201 R1002	80 ... 110	A 145, 185			0.750
TA 200 DU 135	1SAZ 421 201 R1003	100 ... 135	A 145, 185			0.750
TA 200 DU 150	1SAZ 421 201 R1004	110 ... 150	A 145, 185			0.750
TA 200 DU 175	1SAZ 421 201 R1005	130 ... 175	A 145, 185			0.750
TA 200 DU 200	1SAZ 421 201 R1006	150 ... 200	A 145, 185			0.750

Normal starting time class 10 A, V1000 (EExe)

TA 200 DU 110	V1000 1SAZ 421 301 R1002	80 ... 110	A 145, 185			0.750
TA 200 DU 130	V1000 1SAZ 421 301 R1003	100 ... 135	A 145, 185			0.750
TA 200 DU 150	V1000 1SAZ 421 301 R1004	110 ... 150	A 145, 185			0.750
TA 200 DU 175	V1000 1SAZ 421 301 R1005	130 ... 175	A 145, 185			0.750
TA 200 DU 200	V1000 1SAZ 421 301 R1006	150 ... 200	A 145, 185			0.750

Thermal overload relays

TA 450 DU/SU, T 200 DU

Ordering details

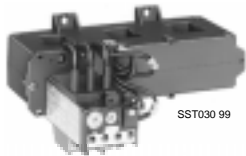

SST030 99

TA 450 DU

Type	Order code	Setting range	For contactor	Price / piece	Pack- ing unit piece	Weight / piece kg
		A ... A				

Normal starting time class 10 A

TA 450 DU 185	1SAZ 511 201 R1001	130 ... 185	A 210, 260, 300			1.500
TA 450 DU 235	1SAZ 511 201 R1002	165 ... 235	A 210, 260, 300			1.500
TA 450 DU 310	1SAZ 511 201 R1003	220 ... 310	A 210, 260, 300			1.500

Normal starting time class 10 A, V1000 (EExe)

TA 450 DU 185 V1000	1SAZ 511 301 R1001	130 ... 185	A 210, 260, 300			1.500
TA 450 DU 235 V1000	1SAZ 511 301 R1002	165 ... 235	A 210, 260, 300			1.500
TA 450 DU 310 V1000	1SAZ 511 301 R1003	220 ... 310	A 210, 260, 300			1.500

Long starting time class 30

TA 450 SU 60	1SAZ 611 201 R1005	40 ... 60	A 145 ... 300			1.500
TA 450 SU 80	1SAZ 611 201 R1006	55 ... 80	A 145 ... 300			1.500
TA 450 SU 105	1SAZ 611 201 R1007	70 ... 105	A 145 ... 300			1.500
TA 450 SU 140	1SAZ 611 201 R1008	95 ... 140	A 145 ... 300			1.500
TA 450 SU 185	1SAZ 611 201 R1001	130 ... 185	A 145 ... 300			1.500
TA 450 SU 235	1SAZ 611 201 R1002	165 ... 235	A 145 ... 300			1.500
TA 450 SU 310	1SAZ 611 201 R1003	220 ... 310	A 145 ... 300			1.500

Long starting time class 30, V1000 (EExe)

TA 450 SU 60 V1000	1SAZ 611 301 R1005	40 ... 60	A 145 ... 300			1.500
TA 450 SU 80 V1000	1SAZ 611 301 R1006	55 ... 80	A 145 ... 300			1.500
TA 450 SU 105 V1000	1SAZ 611 301 R1007	70 ... 105	A 145 ... 300			1.500
TA 450 SU 140 V1000	1SAZ 611 301 R1008	95 ... 140	A 145 ... 300			1.500
TA 450 SU 185 V1000	1SAZ 611 301 R1001	130 ... 185	A 145 ... 300			1.500
TA 450 SU 235 V1000	1SAZ 611 301 R1002	165 ... 235	A 145 ... 300			1.500
TA 450 SU 310 V1000	1SAZ 611 301 R1003	220 ... 310	A 145 ... 300			1.500

Type	Order code	Setting range	For contactor	Price / piece	Pack- ing unit piece	Weight / piece kg

Mounting kits for TA 450 overload relays

DT 450 /A 185	1SAZ 501 901 R1001		A 145, 185			0.470
DT 450 /A 300	1SAZ 501 902 R1001		A 260, 300			0.470

Terminal shroud for TA 200

LT 200/A	1SAZ 401 901 R1001					0.070
----------	--------------------	--	--	--	--	-------

T-Relays for EH-contactors

Type	Order code	Setting range	Max.fuse See page 21 aM gL/gG A A	Price / piece	Pack- ing unit piece	Weight / piece kg
		A ... A				

T 200 DU

for contactors EH 145, EH 150, EH 160, EH 175, EH 210

T 200 DU 110	GJZ 432 1401 R 0002	80 ... 110	200	224		1	0.910
T 200 DU 135	GJZ 432 1401 R 0003	100 ... 135	200	224		1	0.910
T 200 DU 150	GJZ 432 1401 R 0004	110 ... 150	224	250		1	0.910
T 200 DU 175	GJZ 432 1401 R 0005	130 ... 175	250	315		1	0.910
T 200 DU 200	GJZ 432 1401 R 0006	150 ... 200	250	315		1	0.910

T 200 DU ... V 1000 (for EEx e Motors)

for contactors EH 145, EH 150, EH 160, EH 175, EH 210

T 200 DU 135 V1000	GJZ 433 1401 R 0003	100 ... 135	200	224		1	0.910
T 200 DU 150 V1000	GJZ 433 1401 R 0004	110 ... 150	224	250		1	0.910
T 200 DU 175 V1000	GJZ 433 1401 R 0005	130 ... 175	250	315		1	0.910
T 200 DU 200 V1000	GJZ 433 1401 R 0006	150 ... 200	250	315		1	0.910



SST 275 92 R

T 200 DU

Thermal overload relays

T 450 DU, T 450 SU, T 900 DU, T 900 SU

Ordering details



SST 139 90 R

T 450 DU / SU



SST 140 90 R

T 900 DU / SU

Type	Order code	Setting range	Max.fuse		Price / piece	Pack- ing unit piece	Weight / piece kg
			See page 2/16 aM A	gL/gG A			

T 450 DU for contactors EH 160, EH 175, EH 210, EH 250, EH 260, EH 300, EH 370

T 450 DU 185	GJZ 542 1001 R 0001	130 ... 185	355		1	1.500
T 450 DU 235	GJZ 542 1001 R 0002	165 ... 235	400		1	1.500
T 450 DU 310	GJZ 542 1001 R 0003	220 ... 310	500		1	1.500
T 450 DU 400	GJZ 542 1001 R 0004	285 ... 400	630		1	1.500

T 450 DU ... V 1000 (for EEx e motors) for contactors EH 160, EH 175, EH 210, EH 250, EH 260, EH 300, EH 370

T 450 DU 185 V 1000	GJZ 543 1001 R 0001	130 ... 185	355		1	1.500
T 450 DU 235 V 1000	GJZ 543 1001 R 0002	165 ... 235	400		1	1.500
T 450 DU 310 V 1000	GJZ 543 1001 R 0003	220 ... 310	500		1	1.500
T 450 DU 400 V 1000	GJZ 543 1001 R 0004	285 ... 400	630		1	1.500

T 450 SU for contactors EH 160, EH 175, EH 210, EH 250, EH 260, EH 300, EH 370

T 450 SU 60	GJZ 552 1001 R 0005	40 ... 60	125		1	0.700
T 450 SU 80	GJZ 552 1001 R 0006	55 ... 80	160		1	0.700
T 450 SU 105	GJZ 552 1001 R 0007	70 ... 105	200		1	0.700
T 450 SU 140	GJZ 552 1001 R 0008	95 ... 140	315		1	0.700
T 450 SU 185	GJZ 552 1001 R 0001	130 ... 185	355		1	0.700
T 450 SU 235	GJZ 552 1001 R 0002	165 ... 235	400		1	0.700
T 450 SU 310	GJZ 552 1001 R 0003	220 ... 310	500		1	0.700
T 450 SU 400	GJZ 552 1001 R 0004	285 ... 400	630		1	0.700

T 450 SU ... V 1000 (for EEx e motors) for contactors EH 160, EH 175, EH 210, EH 250, EH 260, EH 300, EH 370

T 450 SU 60 V 1000	GJZ 553 1001 R 0005	40 ... 60	125		1	0.700
T 450 SU 80 V 1000	GJZ 553 1001 R 0006	55 ... 80	160		1	0.700
T 450 SU 105 V 1000	GJZ 553 1001 R 0007	70 ... 105	200		1	0.700
T 450 SU 140 V 1000	GJZ 553 1001 R 0008	95 ... 140	315		1	0.700
T 450 SU 185 V 1000	GJZ 553 1001 R 0001	130 ... 185	355		1	0.700
T 450 SU 235 V 1000	GJZ 553 1001 R 0002	165 ... 235	400		1	0.700
T 450 SU 310 V 1000	GJZ 553 1001 R 0003	220 ... 310	500		1	0.700
T 450 SU 400 V 1000	GJZ 553 1001 R 0004	285 ... 400	630		1	0.700

T 900 DU for contactors EH 370, EH 550, EH 700, EH 800

T 900 DU 375	GJZ 602 1001 R 0001	265 ... 375	500		1	3.000
T 900 DU 500	GJZ 602 1001 R 0002	355 ... 500	800		1	3.000
T 900 DU 650	GJZ 602 1001 R 0003	465 ... 650	1000		1	3.000
T 900 DU 850	GJZ 602 1001 R 0004	610 ... 850	1250		1	3.000

T 900 DU ... V 1000 (for EEx e motors) for contactors EH 370, EH 550, EH 700, EH 800

T 900 DU 375 V 1000	GJZ 603 1001 R 0001	265 ... 375	500		1	3.000
T 900 DU 500 V 1000	GJZ 603 1001 R 0002	355 ... 500	800		1	3.000
T 900 DU 650 V 1000	GJZ 603 1001 R 0003	465 ... 650	1000		1	3.000
T 900 DU 850 V 1000	GJZ 603 1001 R 0004	610 ... 850	1250		1	3.000

T 900 SU for contactors EH 370, EH 550, EH 700, EH 800

T 900 SU 375	GJZ 612 1001 R 0001	265 ... 375	500		1	1.500
T 900 SU 500	GJZ 612 1001 R 0002	355 ... 500	800		1	1.500
T 900 SU 650	GJZ 612 1001 R 0003	465 ... 650	1000		1	1.500
T 900 SU 850	GJZ 612 1001 R 0004	610 ... 850	1250		1	1.500

T 900 SU ... V 1000 (for EEx e motors) for contactors EH 370, EH 550, EH 700, EH 800

T 900 SU 375 V 1000	GJZ 613 1001 R 0001	265 ... 375	500		1	1.500
T 900 SU 500 V 1000	GJZ 613 1001 R 0002	355 ... 500	800		1	1.500
T 900 SU 650 V 1000	GJZ 613 1001 R 0003	465 ... 650	1000		1	1.500
T 900 SU 850 V 1000	GJZ 613 1001 R 0004	610 ... 850	1250		1	1.500

Thermal overload relays

Accessories

Ordering details

Mounting kits for mounting thermal overload relays onto contactors

Relays TA 25 DU to TA 200 DU can be mounted onto the contactors without mounting kits .

Mounting kits for single set-ups

Type	Order code	for thermal overload relay	Mounting	Price / piece	Packing unit piece	Weight / piece kg
DB 25/25 A DB 25/32 A	1SAZ 201 108 R 0001 1SAZ 201 108 R 0002	TA 25 DUO25 A TA 25 DU 32 A	snapping onto		1	0.050
					1	0.075
DB 80	1SAZ 301 110 R 0001	TA 42 DU TA 75 DU TA 80 DU	35 mm		1	0.170
DB 200	1SAZ 401 110 R 0001	TA 110 DU TA 200 DU T 200 DU	Screw mounting		1	0.230

FASTON terminal blocks LC ...

Description

The FASTON terminal blocks are supplied as complete mounting kits for thermal overload relays TA 25 DU and as mounting kit for single set-ups DB 25... A maximum of 2 6.3 mm tab connectors or 2 2.8 mm tab connectors can be connected per pole to the FASTON terminal blocks.

⚠ The connection points are safe from finger-touch and safe from touch by the back of the hand to VDE 0106, Part 100.

Type	Order code	Mounting onto :	Price / piece	Packing unit piece	Weight / piece kg
LC 30-T	GJL 280 1912 R 0001	Relay TA 25 DU		1	0.021
LC 26-B1	GJL 280 1912 R 0004	Mounting kit DB 25/25 A + DB 25/32 A		1	0.015

Terminal block 10 mm²

DX 25	1SAZ 20 1307 R 0002	TA 25 DU ≤ 25 A and DB 25/25 A		1	0.030
-------	---------------------	-----------------------------------	--	---	-------

Mounting kits for mounting thermal overload relays onto contactors

AT 450/EH 160	GJZ 520 1901 R 0002	EH 175, EH 210		1set	0.500
AT 450/EH 300	GJZ 520 1909 R 0002	EH 260, EH 300		1set	0.750
AT 450/EH 370	GJZ 520 1903 R 0002	EH 370		1set	1.100
AT 900/ EH 370/ EH 550	GJZ 520 1911 R 0002	EH 370, EH550		1set	0.800
AT 900/ EH 700	GJZ 520 1912 R 0002	EH 700		1set	1.900
AT 900/ EH 800	GJZ 520 1913 R 0002	EH 800		1set	3.000

Identification markers for thermal overload relays TA 25 DU ... T 900 DU

BA 50	FPTN 472 625 R 0001	50 label carriers 50 transparent protection covers 60 non-adhesive labels 75 self-adhesive labels		Bag	0.100
-------	---------------------	--	--	-----	-------

Type	Order code	for contactor	overload relays	Price / piece	Pack. unit piece	Weight / piece kg
------	------------	---------------	-----------------	---------------	------------------	-------------------

Mounting kits for mounting thermal overload relays onto contactors

DT 450/A 185	1 SAZ 50 1901 R1001	A 145, A 185	TA 450		1	0.500
DT 450/A 300	1 SAZ 50 1902 R1001	A 260, A 300	TA 450		1	0.750

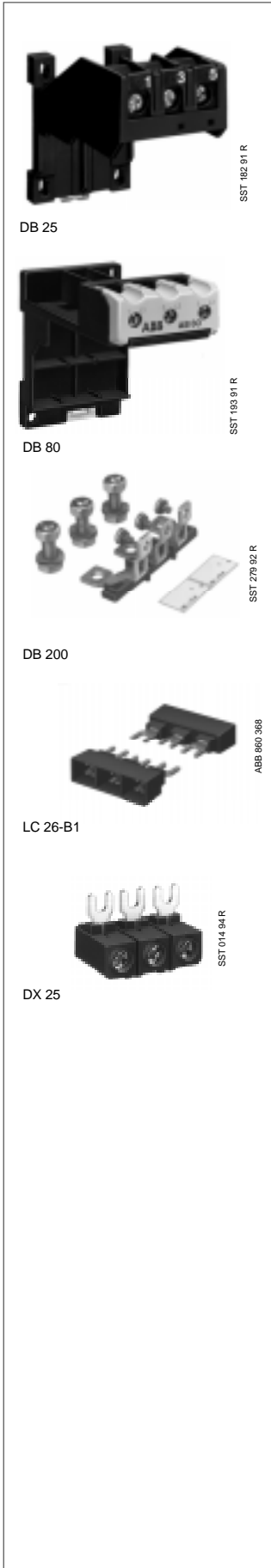

Thermal overload relays

Accessories

Ordering details

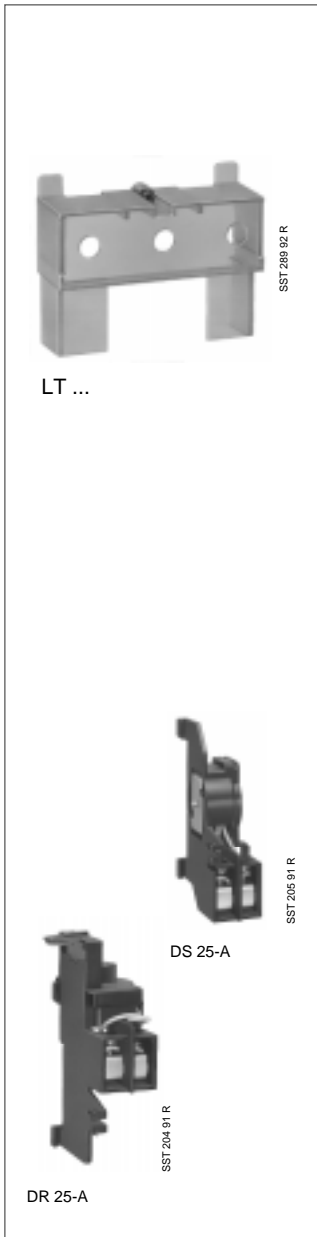

Type	Order code	Mounting onto :	Price / piece	Pack. unit piece	Weight / piece kg
------	------------	-----------------	---------------	------------------	-------------------

Terminal shroud (for protection against direct contact). Contactor terminals and TOL terminals are covered

LT 200/160	GJZ 430 1907 R 0001	T 200 DU + EH 145/150/160			0.150
LT 450/250	GJZ 520 1930 R 0001	T 450 DU/SU + EH 175/210/260/300			0.310
LT 450/370	GJZ 520 1932 R 0002	T 450 DU/SU + EH 370			0.310
LT 900/700	GJZ 520 1935 R 0002	T 900 DU/SU + EH 370/550/700			0.450
LT 900/800	GJZ 520 1937 R 0002	T 900 DU/SU + EH 800			0.600

Terminal shroud for TA 200

LTA 185-AY between A 145/185 and TA 200 DU	1SFN 12 4704 R1000	A 145, A 185		1	1.000
LT 200/A	1SAZ 401 901 R1001	A 145, A 185			0.070

Type	Order code	For relay/ description	Price / piece	Pack. unit piece	Weight / piece kg
------	------------	---------------------------	---------------	------------------	-------------------

Remote tripping control

The coil serves to remotely trip the thermal overload relays TA 25 DU, T 450/900 DU/SU.

The coil is not approved for continuous operation. Pulse duration 0.2 ... 0.35 s.

DS 25-A-24	1SAZ 201 501 R0001	24 V	} Operating-voltage U_c at 50/60 Hz	1	0.100
DS 25-A-48	1SAZ 201 501 R0002	48 V		1	0.100
DS 25-A-110	1SAZ 201 501 R0003	110 V		1	0.100
DS 25-A-220/380	1SAZ 201 501 R0005	220/380 V		1	0.100
DS 25-A-500	1SAZ 201 501 R0006	500 V		1	0.100

Remote reset coil

The coil serves to reset the thermal overload relays TA 25 DU, T 450/900 DU/SU.

The overload relay must be set to "manual reset" for this purpose.

The coil is not approved for continuous operation. Pulse duration 0.2 ... 0.35 s.

DR 25-A-24	1SAZ 201 504 R0001	24 V	} Operating-voltage U_c at 50/60 Hz	1	0.100
DR 25-A-48	1SAZ 201 504 R0002	48 V		1	0.100
DR 25-A-110	1SAZ 201 504 R0003	110 V		1	0.100
DR 25-A-220/380	1SAZ 201 504 R0005	220/380 V		1	0.100
DR 25-A-500	1SAZ 201 504 R0006	500 V		1	0.100

Circuit diagrams

TA 25 DU with DS 25-A

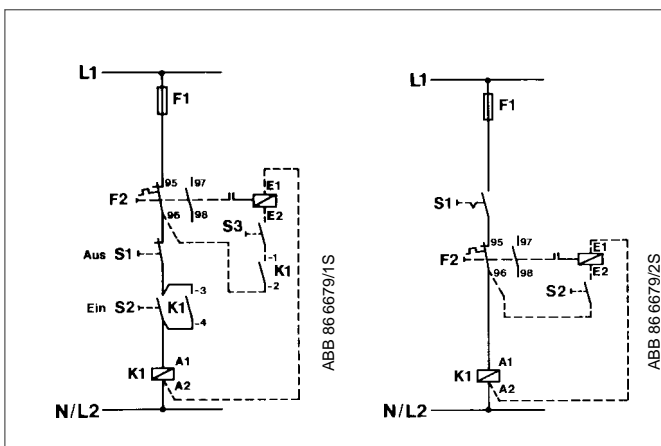

TA 25 DU with DR 25-A

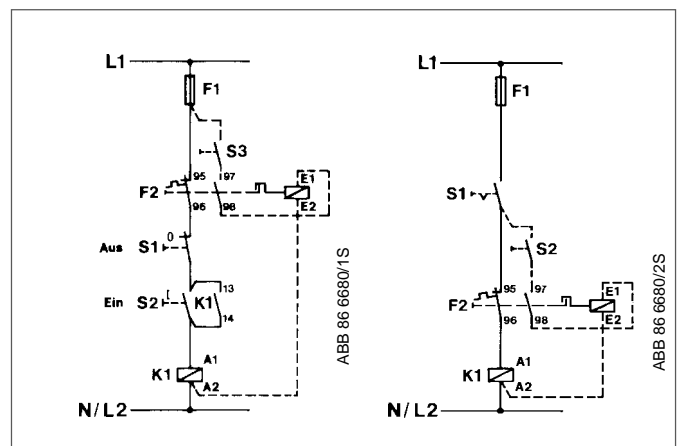

Electronic overload relays E 16 DU

for contactors and mini contactors

Ordering details



SST 016.89

E 16 DU

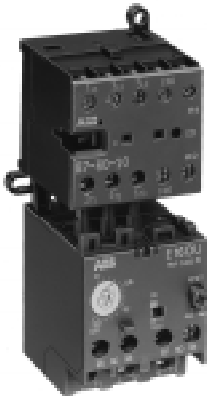

SST 017.89

E 16 DU with B 6, B 7

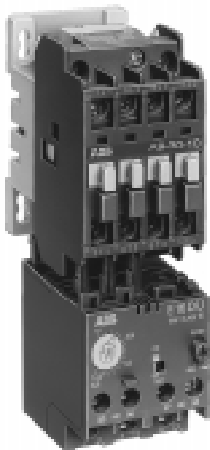

SST 018.89

E 16 DU
with A 9, A 12, A 16

Type	Order code	Setting range		Max. fuse		Price / piece	Pack. unit piece	Weight / piece kg
		A	... A	aM A	gL/gG A			

E 16 DU tripping class 10 for contactors B 6, B 7, BC 6, BC 7, B 6S, B 7S, A 9, A 12, A 16

E16 DU 0.32 10 ①	1SAX 111 201 R 0001	0.1 ...	0.32		1		1	0.150
E16 DU 1.0 10 ①	1SAX 111 201 R 0002	0.3 ...	1.00		4		1	0.150
E16 DU 2.7 10 ①	1SAX 111 201 R 0003	0.9 ...	2.70		10		1	0.150
E16 DU 6.3 10 ①	1SAX 111 201 R 0004	2.0 ...	6.30		20		1	0.150
E16 DU 18.9 10 ①	1SAX 111 201 R 0005	5.7 ...	18.90		50		1	0.150

E 16 DU tripping class 20 for contactors B 6, B 7, BC 6, BC 7, B 6S, B 7S, A 9, A 12, A 16

E16 DU 0.32 20 ①	1SAX 111 301 R 0001	0.1 ...	0.32		1		1	0.150
E16 DU 1.0 20 ①	1SAX 111 301 R 0002	0.3 ...	1.00		4		1	0.150
E16 DU 2.7 20 ①	1SAX 111 301 R 0003	0.9 ...	2.70		10		1	0.150
E16 DU 6.3 20 ①	1SAX 111 301 R 0004	2.0 ...	6.30		20		1	0.150
E16 DU 18.9 20 ①	1SAX 111 301 R 0005	5.7 ...	18.90		50		1	0.150

E 16 DU tripping class 30 for contactors B 6, B 7, BC 6, BC 7, B 6S, B 7S, A 9, A 12, A 16

E16 DU 1.0 30 ①	1SAX 111 401 R 0002	0.3 ...	1.00		4		1	0.150
E16 DU 2.7 30 ①	1SAX 111 401 R 0003	0.9 ...	2.70		10		1	0.150
E16 DU 6.3 30 ①	1SAX 111 401 R 0004	2.0 ...	6.30		20		1	0.150
E16 DU 18.9 30 ①	1SAX 111 401 R 0005	5.7 ...	18.90		50		1	0.150

① Not suitable for single-phase motors and direct current (DC) motors!

Mounting kit for separate mounting electronic overload relay E 16 DU on wall or Din-rail

Mounting kits for single set-ups

Type	Order code	for thermal overload relays	Mounting	Price / piece	Pack. unit piece	Weight / piece kg
DB 16 E	1SAX 101 110 R 0001	E 16 DU	Schraub-/ Hutschiene		1	

DB 16 E

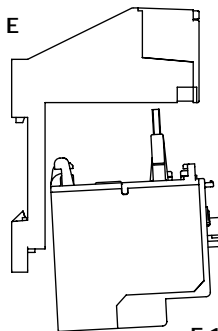

E 16 DU

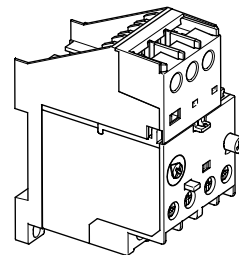

Electronic overload relays E 200/320/500/800 DU

Ordering details

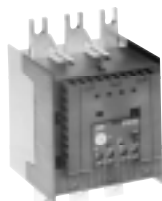

SST 289 9/2 R

E 200 DU

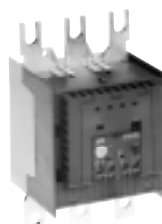

E 320 DU



E 500 DU



E 800 DU



Contactor A 300
with E 320 DU and
terminal shroud

Type	Order code	Setting range	for contactor	Price / piece	Pack. unit piece	Weight / piece kg
------	------------	---------------	---------------	---------------	------------------	-------------------

Electronic overload relays

E 200 DU	1SAX 511 001 R 0001	65 ... 200	A 145 ... A 185		1	0.000
E 320 DU	1SAX 611 001 R 0002	105 ... 320	A 210 ... A 300		1	
E 500 DU	1SAX 711 001 R 0001	170 ... 500	AF 400 ... AF 460		1	
E 800 DU	1SAX 811 001 R 0001	270 ... 800	AF 580 ... AF 750		1	

Type	Order code	description
------	------------	-------------

DT 500/AF 460 | **1SAX 701 902 R 0001** | Mounting kit for AF 400/460

DT 800/AF 750 | **1SAX 801 902 R 0001** | Mounting kit for AF 580/750

The mounting kits includes busbars and accessories for contactor mounting

LT 200 E | **1SAX 501 904R 0001** | Terminal shroud for E 200 DU

LT 320 E | **1SAX 601 904 R 0001** | Terminal shroud for E 320 DU

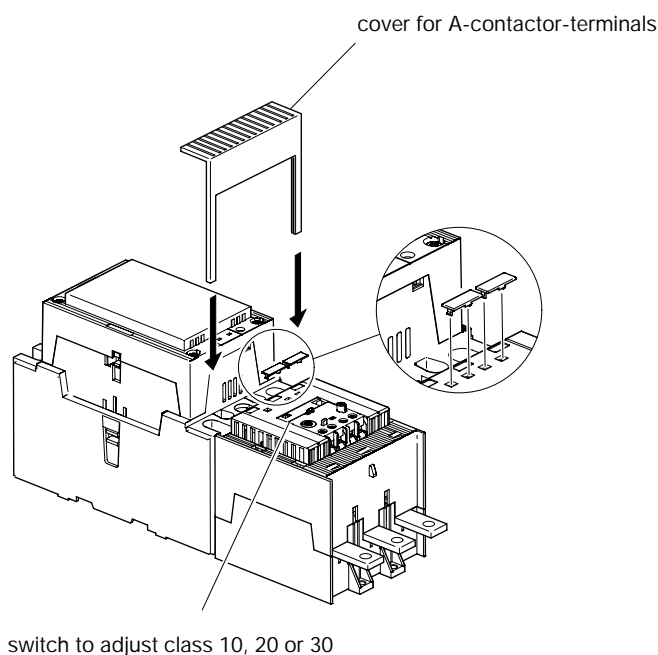

Notes

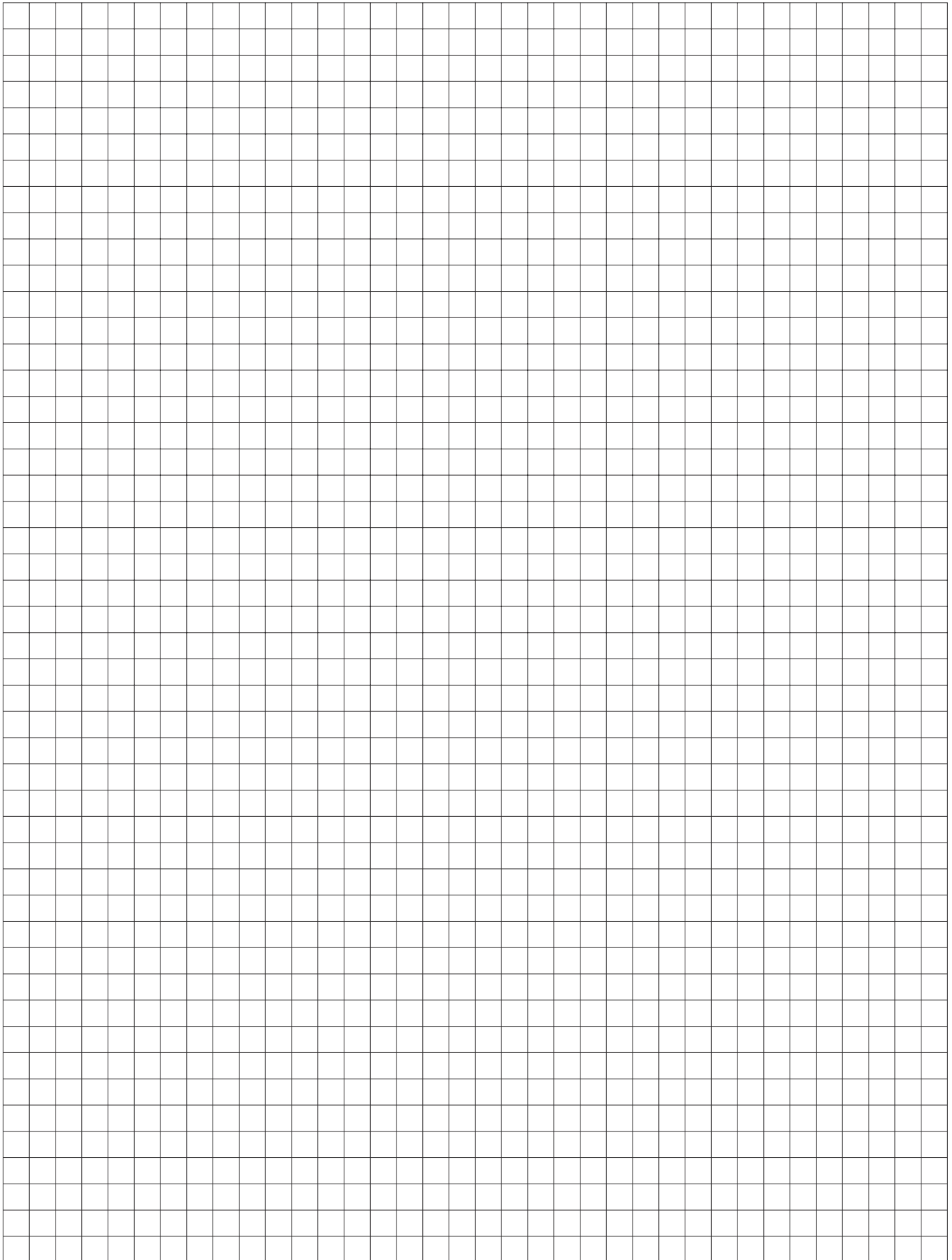

Thermal overload relays T...

Description

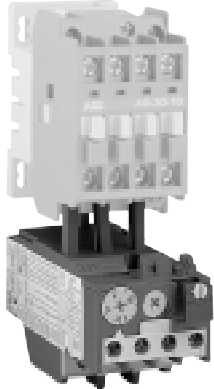

Application

Thermal overload relays T are used in connection with contactors A, BC, AE and EH to protect motors with a rated operating voltage of up to 690 V AC and 800 V DC.

Product range

Standard relays

Types: T 7 DU, TA 25 DU, TA 42 DU, TA 75 DU, TA 80 DU, TA 110 DU, T / TA 200 DU, T / TA 450 DU/SU, T 900 DU/SU

- Relays T 7 to T / TA 200 are connected directly into the motor circuit and the motor current flows through them.
- Relays T / TA 450 DU and T 900 DU are powered via converters with a linear characteristic.
- Relays T / TA 450 SU and T 900 SU are powered via converters with saturation characteristic and therefore have longer tripping times.
See section "Protection with heavy starting", see Page 18

Special designs

Thermal overload relays with different approvals and certificates, see Page 26. Relays to protect Ex e motors, see Page 18

Design and function

General

The relays and the accessories comply with the major international (IEC), European (EN) and national standards (DIN-VDE, NFC-UTE, BS, etc...) and meet the approval and licensing regulations necessary worldwide.

The thermal overload relays are three-pole relays

They have bimetallic releases (1 per phase) through which the motor current flows and are indirectly heated. The bimetallic releases bend subject to the influence of heating and this results in tripping of the relay. The auxiliary contacts change their switch position.

The relays feature a setting scale in Amperes. In compliance with international and national standards, the setting current is the rated **motor current** and not the tripping current (no tripping at 1.05 x I setting current, tripping at 1.2 x I setting current).

The **tripping curves** (starting from cold and warm state, three and two-phase) are shown in the technical data, Page 24.

The relays are constructed so that they protect themselves in the event of overload until the series-connected short-circuit protection trips, as shown in the tables.

Technical data

All relays feature:

- **Trip-free mechanism:** Tripping in the event of a fault is not prevented even if the Reset button is pressed.
- **Temperature compensation:** - see Page 18
- **Phase failure protection in accordance with IEC 947-4-1:** This device shortens the tripping times in the event of phase failure and thus improves the motor protection within the limits of the setting range.
- **Tripping category:** **10 A**, in the case of thermal overload relays T ... DU
30, in the case of thermal overload relays T ... SU.
- **Reset and test functions**, see Page 19

Auxiliary contacts

The relays feature two integrated auxiliary contacts

- one NC contact, marked by 95 - 96
- one NO contact, marked by 97 - 98

The two contacts are electrically isolated and are thus suitable for use in two different circuits (control circuit and signalling circuit).

Thermal overload relays T 7 DU, TA 25 DU ... T 900 DU

Technical data

Intermittent periodic duty



ABB 82 7833

Switching frequency depending on duty ratio ED in %, t_s : Motor starting time

t_s : Motor starting time

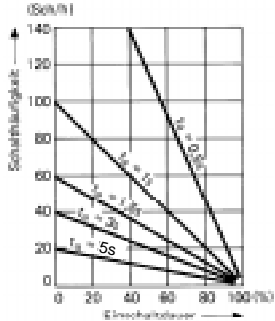

ABB 83 6246

Tripping curve of overload relay T .. starting from cold state

• Switching frequency

Thermal overload relays T cannot be operated at any arbitrary switching frequency in order to avoid tripping. Applications involving up to 15 operations per hour are acceptable. Higher switching frequencies are permitted if the duty ratio and the motor starting time are allowed for and if the motor's making current does not appreciably exceed 6 times the rated operating current. Please refer to the adjacent diagram for guideline values for the permitted switching frequency.

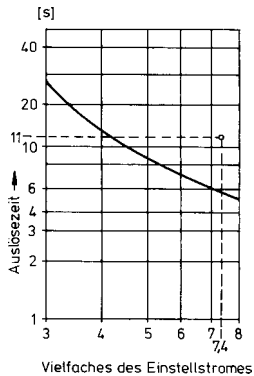
Example: Starting time of the motor: 1 second

Duty ratio: 40 %

means a permitted switching frequency of max. 60 operations per hour

Use of the CUSTORAPID® motor protection is recommended for higher switching frequencies and alternating loading, e.g. for frequent starting and braking. Use of a combination of thermal overload relays and CUSTORAPID® is recommended in the case of locked rotors on motors with thermally critical rotors.

• Protection with heavy starting

Relays T 450SU/T 900SU can be used for particularly severe starting conditions. The setting ranges specified on Pages 41 and 42 apply to non-recurrent looping through of the cables. The relay may also be used for lower motor rated currents. This is achieved by looping the cables through several times. The setting range specified on the rating plate is inversely proportional to the number of cables looped through.

For instance: T 450TU/SU with a setting range of 130 ... 185 A is also suitable for currents of 65 ... 92.5 A if the cables are looped through twice; the figures are 43.3 ... 61.6 A for looping the cables through three times.

• Special version for EEx e motors

Relays T 7 DM, TA 25 DU ... T 900 DU / SU are suitable for protection of EEx e motors. They have been tested and approved by the "German National Standards Laboratory" (PTB) in Braunschweig, Germany.

When selecting the overload relay, check suitability on the basis of the tripping curves. The values for the ratio of pick-up current I_a to rated current I_n and the shortest t_E time are crucial, and these must be specified on the PTB Approval Certificate and on the motor's rating plate. The relay must trip within the t_E time, i.e. the tripping curve, starting from cold state, must run below the coordinate point I_a/I_n and the t_E time.

• Example for suitability of an overload relay T/TA:

The motor with increased safety has the following data:

Output = 7.5 kW, $I_a/I_n = 7.4$ t_E time = 11 seconds.

In accordance with the adjacent tripping curve, the tripping time lies below the t_E time of the motor. The special relay version for EEx e motors differs from the normal version as follows:

• Special test of the tripping times at the works

• Special order code

Tripping curves for the individual setting ranges and the PTB Approvals Certificates may be ordered.

• Reference numbers of the PTB:

Type	Reference No. of the PTB	Type	Reference No. of the PTB
T 7 DU V 1000	3.43-187/98	T / TA 200 DU V 1000	3.53-5315/93
TA 25 DU V 1000	3.53/38 7.3023	T / TA 450 DU, T900 DU V 1000	3.53/38 1.671
TA 42 DU, TA 75 DU, TA 80 DU V 1000	3.53/38 0.418	T 450 SU, T900 SU V 1000	3.53/38 1.672
TA 110 DU V 1000	3.43-760/98		

Limit values for tripping at ambient temperatures other than 20 °C

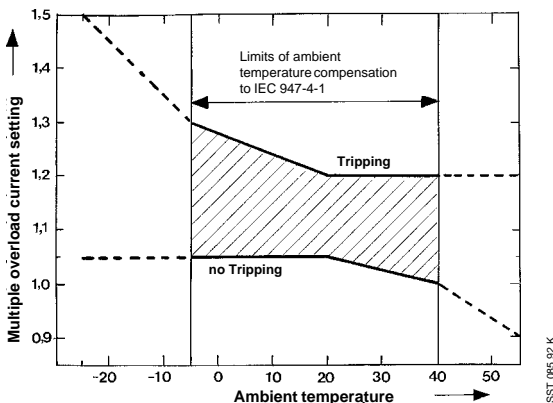

SST 085 92 K

• Ambient temperature compensation :

The overload relays are protected against influences of ambient temperature by a bimetallic compensation element which detects the ambient temperature.

This design means that tripping occurs between -5 °C and +40 °C within the ranges defined by IEC 947-4-1. See the adjacent curve for the extended range of -25 °C resp. +55 °C.

• Example :

Tripping at -25 °C. Tripping occurs at ≤ 1.5 times the setting current.

• Reset :

Types E 16 DU, T 7 DU, TA 25 DU ... T 900 DU/SU feature a convertible Manual/Automatic reset.

• Condition as delivered :

Manual reset.

Thermal overload relays T...

Technical data

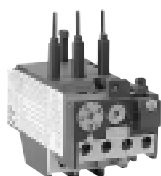

TA 25 DU

SE 7386

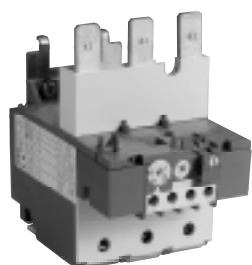

TA 110 DU

SE 7398

Load rating of auxiliary contacts

Type	T7 DU		TA25 DU ... T900 DU/SU	
	NC 95 - 96	NO 97-98	NC 95 - 96	NO 97 - 98
Auxiliary switch				
Rated operating voltage U_e	V	500	500	
Rated thermal current I_{th}	A	6	10	6
Rated operating current I_e				
at AC 15 to 240 V	A	1.5	3	1.5
at AC 15 to 440 V	A	0.7	1.9	0.95
at AC 15 to 500 V	A	0.5	1	0.75
at DC 13 to 24 V	A	-	1.25	0.42
to 60 V	A	-	0.50	0.17
to 120 V	A	-	0.25	0.08
to 250 V	A	0.2	0.12	0.04
Maximum potential difference between the NO and NC contacts	AC V	500	500	
	DC V	440	440	
Short-circuit protection	gL/gG A	4	10	6
STOTZ circuit-breaker type:				
S 271	A	K1	K3	K1
S 281	A	K1	K3	K1

Function of the thermal overload relays TA 25 DU ... T 900 DU/SU

Press blue button	Contacts	Relay tripped		Relay not tripped	
		Manual	Automatic	Manual	Automatic
	NC 95-96 NO 97-98	open closed	open closed	closed open	closed open
☞ Button R	NC 95-96 NO 97-98	Reset closes when Button's pressed opens when Button's pressed	- - -	- - -	- - -
☞ Button R/O	NC 95-96 NO 97-98	Reset closes when Button's released opens when Button's pressed	- - -	opens when Button's pressed closes when Button's released -	opens when Button's pressed closes when Button's released -

Position of the connection terminals

TA 25 DU, TA 42 DU,
TA 75 DU, TA 80 DU

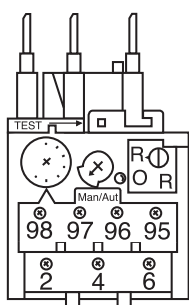

A 471

T 200 DU

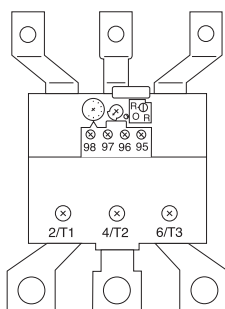

A 467

T 450 DU/SU, T 900 DU/SU

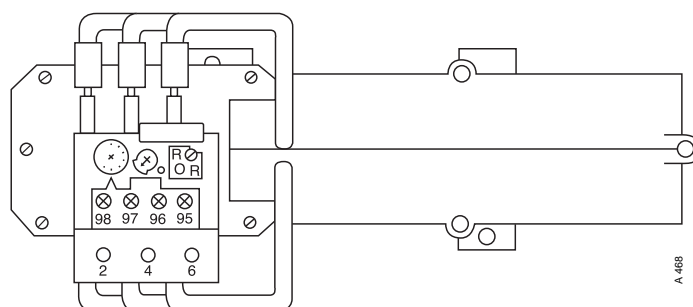



A 468

Thermal overload relays T

Technical data

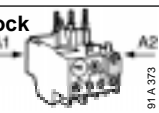
General technical data

Type	T 7 DU	TA 25 DU	TA 42 DU	TA 75 DU
Standards: (major international European and national standards)	IEC 947-4-1, VDE 0660, NFC 63 650, BS 4941, EN 60947-4-1			
Approvals, certificates	see page 26			
Rated insulation voltage U_i to IEC 158-1, IEC 947-4-1	V	690	660/690	
Impulse withstand voltage U_{imp} to IEC 947-4-1	kV	6	6	
Permissible ambient temperature – Storage temperature – for operation (compensated)	°C °C	– 40 to +70 – 25 to +55 (limit values, see page 18)		
Climatic resistance to DIN 50017	Resistant to changeable climate KFW, 30 cycles			
Mounting position	any, but please avoid vertical mounting position wherever possible			
Resistance to shock at rated current I_n • critical shock direction A1, A2	shock duration ms 		15	
	multiple of g	10	12	
Resistance to vibration: (±1 mm, 50 Hz)	multiple of g	4	8	
Mounting – onto contactor – with AB.. mounting kit	hooking beneath the contactor, screwing on its main terminals by screws: 2 x M4 or  35 mm EN 50022			
Connection terminals and attachment type Main conductors (motor side)	TA25DU setting ranges: 0.1...0.16 A 24...32 A to 18...25 A			
• Screw terminals – Screw terminal – with terminal block – with busbars or cable lugs	M3.5 – –	M4 – –	– M5 –	M6 – –
• Connection cross-sections – single-core or stranded – flexible with wire end ferrule – busbars	mm ² mm ² mm	2 x 0.75 ... 2.5 2 x 0.5 ... 1.5 –	– – –	1 x 2.5 ... 25 or 2 x 2.5 ... 16 1 x 2.5 ... 25 or 2 x 2.5 ... 10 –
Connections and auxiliary connectors • Screw terminal (screw size) – with self-disengaging clamping piece	M 3.5			
• Connection cross-section – single-core or stranded – flexible with wire end ferrule	mm ² mm ²	2 x 0.75 ... 2.5 2 x 0.5 ... 1.5	2 x 0.75 ... 4 2 x 0.75 ... 2.5	
Enclosure to IEC 144, IEC 529	All terminals are safe from finger-touch and safe from touch by the back of the hand to VDE 0106, Part 100 (no extra terminal shrouds are required up to and including TA 110 DU)			

Technical data of the conducting paths

Type	T7 DU	TA25 DU	TA42 DU	TA75 DU	TA80 DU	TA110 DU	T/TA200 DU	T/TA450 DU	T900 DU	T/TA450 SU/T900 SU
Number of paths	3									
Setting ranges	see Ordering details									
Tripping class to IEC 947-4-1 / VDE 0660, Part 1021	10 A								30	
Frequency range Hz	0 ... 400							50/60		
Switching frequency without early tripping	up to 15 ops./h or 60 ops./h with 40 % if the breaking current does not exceed $6 \times I_n$ and the starting time does not exceed 1 s									
Resistance per phase in mΩ and heat dissipation per phase in W at maximum setting current	see page 22 and 23									
Required fuses for short-circuit protection	see page 22 and 23									

Thermal overload relays T

Technical data

General technical data (cont.)

	TA 80 DU	TA 110 DU	T/TA 200 DU	T/TA 450 DU/SU	T 900 DU/SU
	IEC 947-4-1, VDE 0660, NFC 63 650, BS 4941, EN 60947-4-1				
	see page 26				
V	660/690			1000	
kV	6			8	
°C	- 40 to +70				
°C	- 25 to +55 (limit values, see page 18)				
	Resistant to changeable climate KFW; 30 cycles				
	any, but please avoid vertical mounting position wherever possible				
ms	15				
x g	12				
x g	8				
	M6 –	4 screws M5			4 screws M6
	M6 – –	HC, M8 – –	– – M10	– – M10	– – M10
mm ²	1 x 2.5 ... 25 or 2 x 2.5 ... 16	16 ... 35	25 ... 120	2 x 240	2 x 300
mm ²	1 x 2.5 ... 25 or 2 x 2.5 ... 10	16 ... 35	25 ... 95	2 x 240	2 x 300
mm	–	–	20 x 4	25 x 5	40 x 5, 6 and 8
	M 3.5				
mm ²	2 x 0.75 ... 4				
mm ²	2 x 0.75 ... 2.5				
	All terminals are safe from finger-touch and safe from touch by the back of the hand to VDE 0106, part 100.		All terminals are safe from finger-touch and safe from touch by the back of the hand to VDE 0106, part 100, only with additional terminal shrouds.		

Thermal overload relays T

Technical data

Resistances and power losses per phase Short-circuit protection

Setting ranges	Short-circuit protection (fuses, circuit-breakers)			Assignment class 1 (1)		Resistance per phase	Power loss per phase at upper current setting
	Assignment class 2 (1)			Assignment class 1 (1)			
from ... to	gL/gG	aM	S 223 K	gL/gG	S 223 K	mΩ	W
A ... A	A	A	A	A			

Thermal overload relay T 7 DU

0.1 ... 0.16	0.5			20	K 6	62.300	1.6
0.16 ... 0.24	1			20		27.000	1.6
0.24 ... 0.40	2			20		11.700	1.9
0.4 ... 0.60	2			20		4.610	1.7
0.6 ... 1.00	4			20		1.660	1.7
1.0 ... 1.60	6			20		0.630	1.6
1.6 ... 2.40	6			20	K 10	0.270	1.6
2.4 ... 4.00	10			20		0.107	1.7
4.0 ... 6.00	10			20		0.049	1.8
6.0 ... 9.00	10			20	K 25	0.021	1.7
9.0 ... 12.00	20			20		0.010	1.4

Setting ranges	Short-circuit protection (fuses, circuit-breakers)			Assignment class 1 (1)		Resistance per phase	Power loss per phase at upper current setting
	Assignment class 2 (1)			Assignment class 1 (1)			
from ... to	gL/gG	aM	S 223 K	gL/gG	S 223 K	mΩ	W
A ... A	A	A	A	A			

Thermal overload relay TA 25 DU

0.1 ... 0.16	0.5	–	–	25	K6	85850.000	2.2
0.16 ... 0.25	0.63	–	–	25		35150.000	2.2
0.25 ... 0.4	1.25	–	0.5	25		13750.000	2.2
0.4 ... 0.63	2	–	1.0	25		5370.000	2.2
0.63 ... 1.00	4	2	1.0	25		2190.000	2.2
1.0 ... 1.40	4	2	1.6	25		1120.000	2.2
1.3 ... 1.80	6	4	2	25		670.000	2.2
1.7 ... 2.40	6	4	3	25	K10	383.000	2.2
2.2 ... 3.10	10	6	3	25		229.000	2.2
2.8 ... 4.00	10	6	4	25		137.000	2.2
3.5 ... 5.00	16	10	6	25		87.500	2.2
4.5 ... 6.50	20	16	8	25	K25	51.000	2.2
6.0 ... 8.50	25	20	10	25		30.400	2.2
7.5 ... 11.00	35	25	16	–		18.200	2.2
10 ... 14.00	35	25	16	–		11.200	2.2
13 ... 19.00	50	35	20	–	K40	6.300	2.3
18 ... 25.00	63	50	25	–		4.700	2.9
24 ... 32.00	80	63	32	–		3.2.000	3.3

(1) Assignment class 1 to IEC 947-4-13: A short-circuit may cause damage to the relay necessitating exchange. (Corresponds to class a to IEC 292-1)
Assignment class 2 to IEC 947-4-12: No damage or changes to the response values occur in the event of a short-circuit (corresponds to class c to IEC 292-1).

Thermal overload relays T

Technical data

Resistances and power losses per phase Short-circuit protection

Setting range from ... to A A	Short-circuit protection (fuses, circuit-breakers) Assignment class 2 (1)				Assignment class 1(1)		Resistance per phase mΩ	Power loss per phase at upper current setting W
	gL / gG	aM	S 273	S 703	gL / gG			
	A	A	A	A	A			

Thermal overload relay TA 42 DU

18 ... 25	63	50	50	50	160		5.5	3.43
22 ... 32	80	63	50	50	160		2.89	2.91
29 ... 42	100	80	63	63	160		1.84	3.24

Thermal overload relay TA 75 DU

18 ... 25	63	50	50	50	160		5.5	3.43
22 ... 32	80	63	50	50	160		2.89	2.91
29 ... 42	100	80	63	63	160		1.84	3.24
36 ... 52	125	100	63	80	160		1.3	3.51
45 ... 63	160	125	–	100	250		0.936	3.72
60 ... 80	200	160	–	100	250		0.615	3.94

Thermal overload relay TA 80 DU

29 ... 42	100	80	63	63	160		1.84	3.24
36 ... 52	125	100	63	80	160		1.3	3.51
45 ... 63	160	125	–	100	250		0.936	3.72
60 ... 80	200	160	–	100	250		0.615	3.94

Setting range from ... to A A	Short-circuit protection (fuses, circuit-breakers) Assignment class 2 (1)		Assignment class 1 (1)		Resistance per phase mΩ	Power loss per phase at upper current setting W
	gL/gG	aM	gL/gG			
	A	A	A			

Thermal overload relay TA 110 DU

65 ... 90	200	160	250	0.540	4.37
80 ... 110	224	200	315	0.378	4.57

Thermal overload relay TA 200 DU

100 ... 135	224	200	315	0.318	5.79
110 ... 150	250	224	355	0.255	5.74
130 ... 175	315	250	400	0.214	6.55
150 ... 200	315	250	500	0.182	7.28

Thermal overload relay TA 450 SU

40 ... 60	125	100	not applicable	–	2.2
55 ... 80	160	125	to	–	2.2
70 ... 105	200	160	overload relays with	–	2.2
95 ... 140	315	250	current transformer	–	2.2

Thermal overload relay TA 450 DU/SU

130 ... 185	355	250	not applicable	–	2.2
165 ... 235	400	315	to	–	2.2
220 ... 310	500	400	overload relays with	–	2.2
285 ... 400	630	500	current transformer	–	2.2

Thermal overload relay TA 900 DU/SU

265 ... 375	500	400	not applicable	–	2.2
355 ... 500	800	630	to	–	2.2
465 ... 650	1000	800	overload relays with	–	2.2
610 ... 850	1250	1000	current transformer	–	2.2

(1) Assignment class 1 to IEC 947-4-13: A short-circuit may cause damage to the relay necessitating exchange. (Corresponds to class a to IEC 292-1)
Assignment class 2 to IEC 947-4-12: No damage or changes to the response values occur in the event of a short-circuit (corresponds to class c to IEC 292-1).

Thermal overload relays

T 7 DU, TA 25 DU ... T 200 DU, T 450 DU, T 900 DU

Tripping curves



TA 25 DU



TA 42 DU

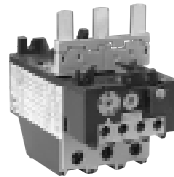

TA 75 DU

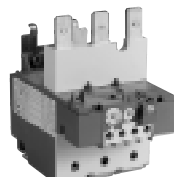

TA 110 DU

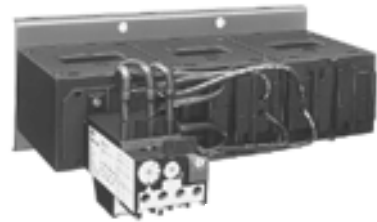

T 900 DU

Thermal overload relays T ... DU are three-pole relays which can be converted from manual to automatic reset. The Reset button can also be used for disconnection. The built-in auxiliary contacts are electrically isolated and are therefore suitable for two different circuits

(control circuit and signalling circuit). All relays feature a facility for temperature compensation and phase failure protection. The overload relays up to size TA 110 DU are safe from finger-touch and safe from touch by the back of the hand.

Terminal shrouds are available for size T 200 DU to T 900 DU/SU. Terminal connections are delivered in open position, with Pozidrive cross-head screws (\pm) and screwdriver guide.

Tripping curves of the thermal overload relays (group curves)

T 7 DU

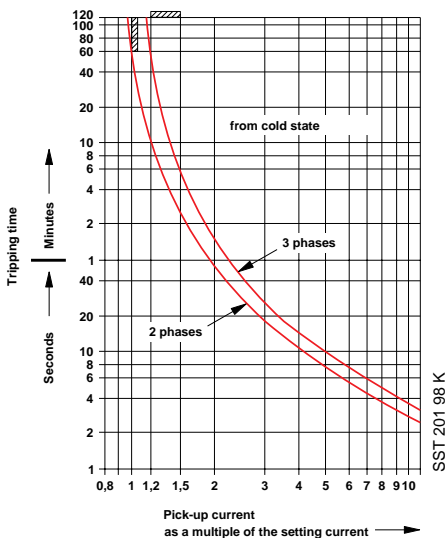

TA 25 DU

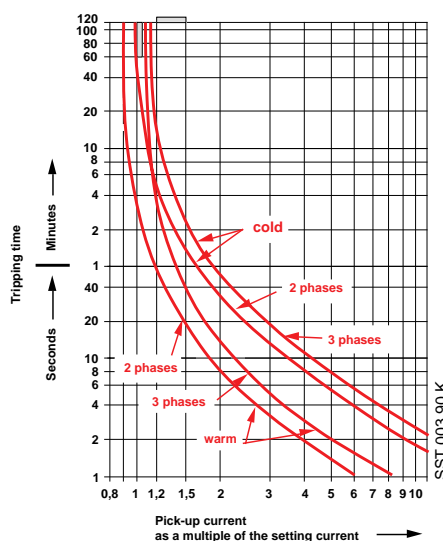

TA 42 DU / TA 75 DU / TA 80 DU

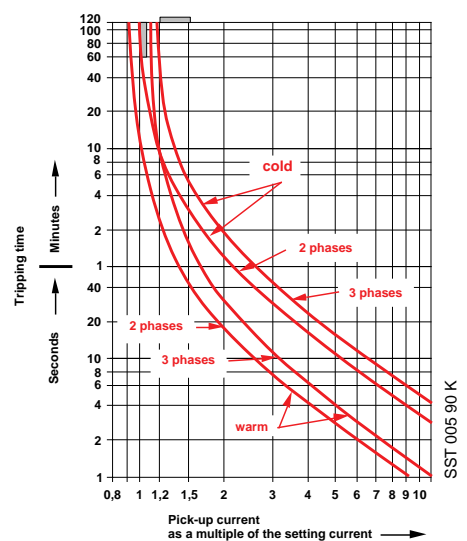

T / TA 200 DU

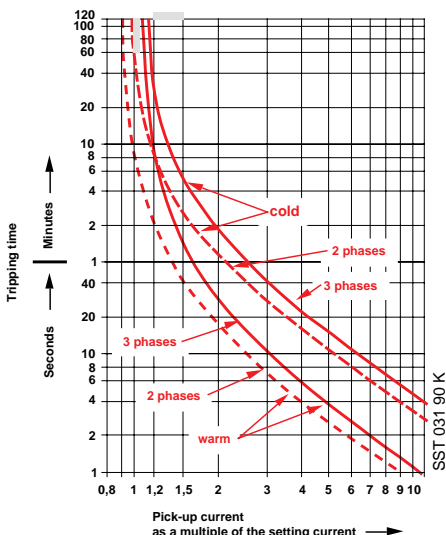

T 450 DU / T 900 DU

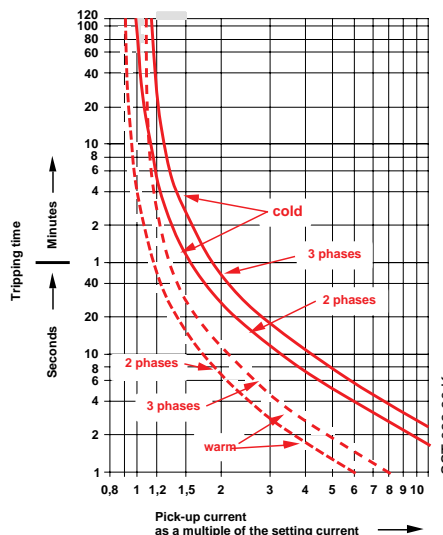

T / TA 450 SU / T 900 SU

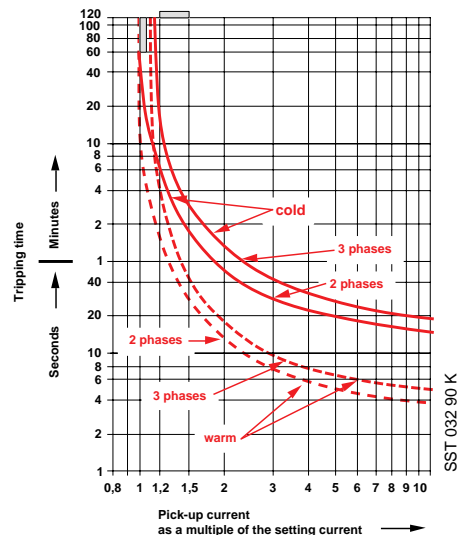

Thermal overload relays T..., V 1000

for EEx e motors

Selection table

Selection table for suitability of the overload relays for EEx e motors.

Tripping times of the thermal overload relays as a function of a multiple of the setting current from cold state (tolerance ± 20 of the tripping time); PTB approvals, see Page 18

Setting range of the thermal overload relays from ... to A A		Tripping times of the thermal overload relays at multiple of setting current:					
		3	4	5	6	7.2	8
		s	s	s	s	s	s

Thermal overload relays TA 25 DU ... V 1000

0.1 ... 0.16	17.3	10	7	5.6	4.5	4
0.16 ... 0.25	16.8	10	7.2	6	4.7	4.3
0.25 ... 0.4	16.3	10	7	5.6	4.4	3.9
0.4 ... 0.63	17.3	10.3	7.1	5.7	4.5	4
0.63 ... 1.0	20	12.6	8.4	6.7	5.3	4.5
1.0 ... 1.4	18.3	11.2	8	6.3	5	4.6
1.3 ... 1.8	18.8	11.1	7.5	6	4.7	4.2
1.7 ... 2.4	19.6	11.5	8	6	4.9	4.5
2.2 ... 3.1	18.3	10.5	7.6	6	4.7	4.2
2.8 ... 4.0	18.8	11.2	8	6.1	4.7	4.2
3.5 ... 5.0	17.8	10.9	7.7	6	4.5	4.1
4.5 ... 6.5	17.8	10.5	7.5	5.6	4.6	4
6.0 ... 8.5	17.8	10.9	7.7	6.1	5	4.5
7.5 ... 11	18.8	11.5	8.3	6.5	5.1	4.5
10 ... 14	17.8	10.9	7.7	6	4.7	4.2
13 ... 19	20.5	11.9	8.8	6	4.7	4
18 ... 25	22.4	13.3	8	6.8	5	4.5
24 ... 32	23.7	14	10	7.7	6	5.3

Thermal overload relays TA 42 DU, TA 75 DU, TA 80 DU ... V 1000

18 ... 25	41	23.2	16	11.8	9 7.5
22 ... 32	37	21	13.8	10.6	8 6.8
29 ... 42	34	18.5	12.6	9.5	6.8 6
36 ... 52	43	23.9	16.1	11.8	9 7.3
45 ... 63	37.4	21.3	15.2	10.6	7.6 6.6
60 ... 80	46.7	23	15.7	11.5	7.9 6.7

Thermal overload relays TA 110 DU ... V 1000

66 ... 90	32	16.7	11.5	8.5	6.3	5.4
80 ... 110	34.5	18.2	12.2	8.8	6.7	5.1

Thermal overload relays TA 200 DU ... V 1000

66 ... 90	27.7	15.8	10.6	7.9	5.6	4.9
80 ... 110	25.1	14.1	9.7	7.1	5.2	4.5
100 ... 135	24.4	13.3	8.9	6.3	4.6	4
110 ... 150	30	15.8	10.6	7.5	5.6	4.6
130 ... 175	30.1	15.8	11.0	7.5	5.6	5.0
150 ... 200	42.2	21.8	14.5	10.3	7.3	6

Thermal overload relays T 450 DU ... V 1000

130 ... 185	14.9	8.9	7.1	5.6	4.5	4.2
165 ... 235	18	10	7.1	5.5	4	3.8
220 ... 310	16.8	10	7.1	5.7	4.7	4
285 ... 400	17	10	7.5	5.5	4.3	4

Thermal overload relays T 900 DU ... V 1000

265 ... 375	16	8.9	7	5.5	4.2	3.8
355 ... 500	17	10.6	7.5	6	4.5	4
465 ... 650	20	11.9	7.9	6	5	4.5
610 ... 850	18.8	11.2	7.9	6	4.7	4.2

Cross-sections of cables for test

in accordance with VDE 0660, Part 100

(IEC 947-1) German version EN 60 947-1

Table 1). Copper test conductor for test currents up to 400 A.

Test current range ¹⁾ (A)		Conductor cross-section ^{2), 3), 4)}	
		(mm ²)	AWG / MCM
0	8	1,0	18
8	12	1,5	16
12	15	2,5	14
15	20	2,5	12
20	25	4,0	10
25	32	6,0	10
32	50	10	8
50	65	16	6
65	85	25	4
85	100	35	3
100	115	35	2
115	130	50	1
130	150	50	0
150	175	70	00
175	200	95	000
200	225	95	0000
225	250	120	250
250	275	150	300
275	300	185	350
300	350	185	400
350	400	240	500

Table 2). Copper test conductor for test currents over 400 A to 800 A.

Test current range ¹⁾ (A)		Conductor cross-section ^{2), 3), 4)}			
		metric		MCM	
		Num-ber	Cross-section (mm ²)	Num-ber	Cross-section (mm ²)
400	500	2	150	2	250
500	630	2	185	2	350
630	800	2	240	3	300

Table 3). Copper test buses for test currents over 400 A to 3150 A.

Test current range ¹⁾ (A)		Copper buses ^{2), 3), 4), 5), 6)}		
		Num-ber	Cross-section (mm ²)	Dimensions (inches)
400	500	2	30 x 5	1 x 0,250
500	630	2	40 x 5	1,25 x 0,250
630	800	2	50 x 5	1,5 x 0,250
800	1000	2	60 x 5	2 x 0,250
1000	1250	2	80 x 5	2,5 x 0,250
1250	1600	2	100 x 5	3 x 0,250
1600	2000	3	100 x 5	3 x 0,250
2000	2500	4	100 x 5	3 x 0,250
2500	3150	3	100 x 10	6 x 0,250

Footnotes to Tables 1, 2 and 3:

- 1) The test current must be higher than the first value in the first column and must be lower than or the same as the second value in this column.
- 2) To simplify the testing procedure and with the consent of the manufacturer, conductors with a smaller cross-section than the one determined for the test current may be used.
- 3) The table shows cross-sections of conductors alternatively in the metric system and in the AWG/MCM system and buses in mm and inches. A

comparison of the AWG/MCM system and metric cross-sections is given in Table 1.

- 4) Optionally, either one of the two conductors given for the test current range may be used.
- 5) It is assumed that buses with the larger surface area are arranged vertically. Buses may be arranged horizontally if so directed by the manufacturer.
- 6) If 4 buses are used, they must be arranged in two pairs with a mean clearance of at most 100 mm.









General technical data

Approvals and certificates

Explanation of symbols:

- Normal version approved: Rating plates bear the test mark if mandatory.
- Special design approved

- Submitted for approval, delivery time on request
- No approval required except in special cases
- △ Submission for approval intended
- ▲ Approved with restrictions

Unit type	Approvals				Ships' classification societies							
Test mark				Phys.-Technische Bundesanstalt								
Abbreviation valid for	CSA Canada	UL USA	UL USA	Germany	France	Germany	Great Britain	Norway	Poland	Italy	Russia	

Thermal overload relays

T 7 DU	■		■	■	■	□	□				
TA 25 DU	■		■	■	■	■	■	■	△	■	△
TA 42 DU	■		■	■	■	■	■	■	△	■	△
TA 75 DU	■		■	■	■	■	■	■	△	■	△
TA 80 DU	■		■	■	□	■	□	□	△	△	△
TA 110 DU	■		■	■	□	■	□	□	△	△	△
T / TA 200 DU	■		■	■	■	■	■	■	■	■	■
T / TA 450 DU/SU	■		■	■	■	■	■	■ (2)	■	■	■
T 900 DU/SU	■		■	■	■	■	■	■ (2)	■	■	■

(2) except Types SU.

Notes

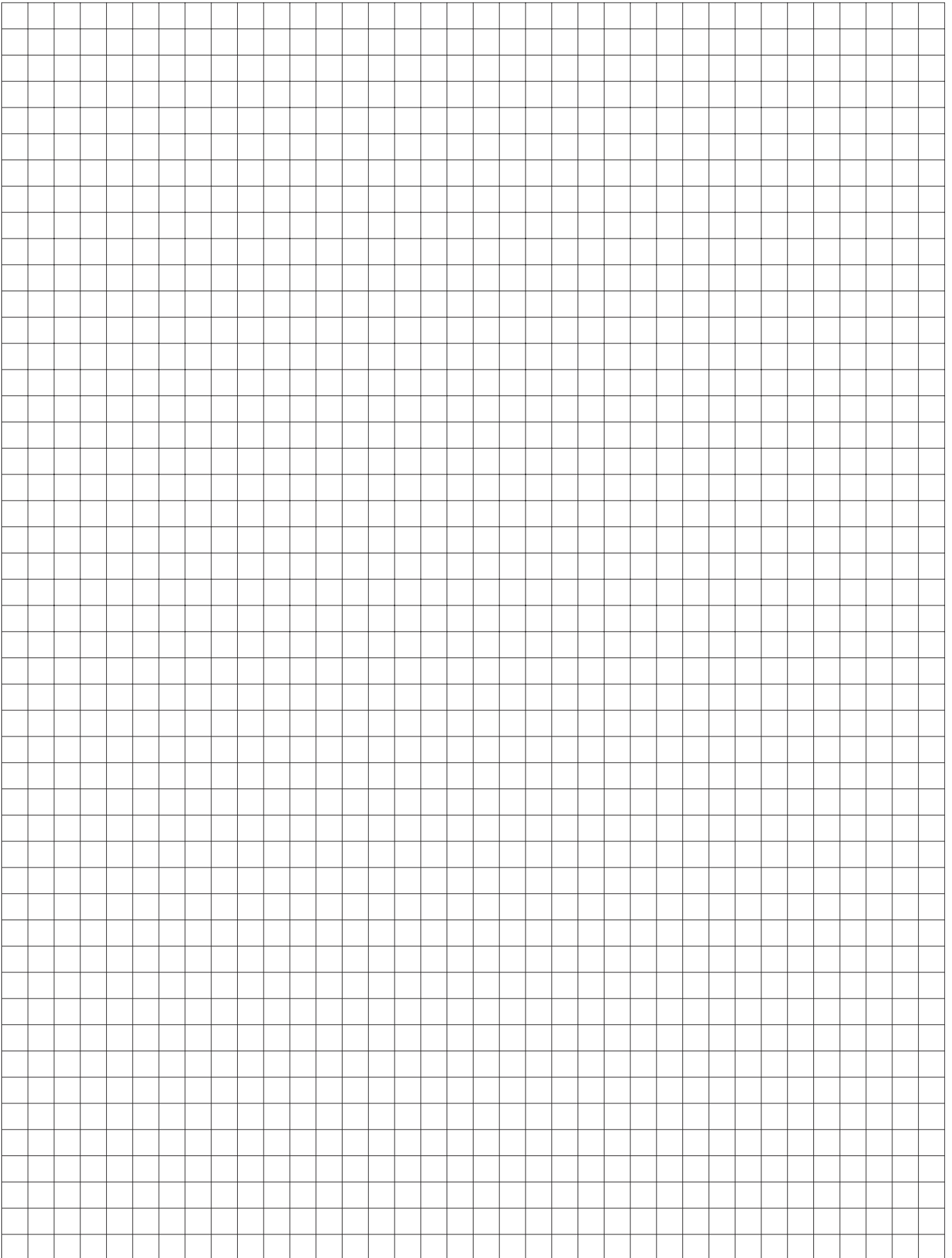

Electronic overload relays E 16 DU

for contactors and mini contactors

Technical data

General technical data

Type	E 16 DU	
Standards: (major European and international standards)	IEC 60 947-4-1 / IEC 60 947-5-1 EN 60 947-4-1 / EN 60 947-5-1	
Approvals and certificates	see page 31	
Rated insulation voltage U_i	V	690
Rated operating voltage U_e		690
Impulse withstand voltage U_{imp}	kV	6
Permissible ambient temperature		
- Storage	°C	- 25 to +70
- Operation	°C	- 25 to +70
Climatic resistance to	IEC 68-2-1, IEC 68-2-2, IEC 68-2-14, IEC 68-2-30	
Mounting position	any	
Resistance to shock	Shock duration ms	11
	multiple of g	15
Resistance to vibrations (±1 mm, 10 ... 100 Hz)	multiple of g	- 5
Mounting	- onto contactor - with AB.. mounting kit for single set-ups	hooking on contactors, screwing on in main terminals by screws: 2 x M4 or 
Connection terminals and attachment type		
Main conductors (load side)/and auxiliary contacts.		
• Screw terminal (screw size)		M3.5
- with self-disengaging clamping piece		-
- with terminal block		-
- with busbars or cable lugs		-
- Tightening torque	Nm	1
• Connection cross-sections		
- single-core or stranded	mm²	2 x 0.75...4
- flexible with wire end ferrule	mm²	2 x 0.75...4
Enclosure to IEC 947-1/EN 60 947-1	All terminals are safe from finger-touch and safe from touch by the back of the hand to VDE 0106, Part 100	

Technical data of the conducting paths

Type	E 16 DU	
Number of conducting paths	3	
Setting ranges	see ordering details	
Tripping classes to IEC 947-4-1/EN 60 947-4-1	see ordering details	
Frequency range	Hz	50 and 60
Switching frequency without early tripping	80 ops./h with 40% if the making current does not exceed 6 x I_n and the starting time does not exceed 1s.	
Resistance per phase in Ω and power loss per phase in W at max. setting current	see page 31	
Required fuses for short-circuit protection	see page 31	

Dimension diagrams see page 32

Electronic overload relays E 16 DU

for contactors and mini contactors

Technical data

Load rating of auxiliary switches

Type	E 16 DU		
	NC 95-96	NO 97-98	
Rated operating voltage U_e	V	600	600
Rated thermal continuous current	A	6	6
Rated operating current I_e			
at AC-15 230 V	A	3	3
at AC-15 400 V	A	1.1	1.1
at AC-15 500 V	A	0.9	0.9
at AC-15 690 V	A	0.7	0.7
at DC-13 24 V	A	1.5	1.5
at DC-13 60 V	A	0.5	0.5
at DC-13 110 V	A	0.4	0.4
at DC-13 220 V	A	0.2	0.2
Short-circuit protection	gL A	6	6
STOTZ safety circuit-breaker: S271 S281		*	*

* on request

Tripping curves for electronic overload relay E ...

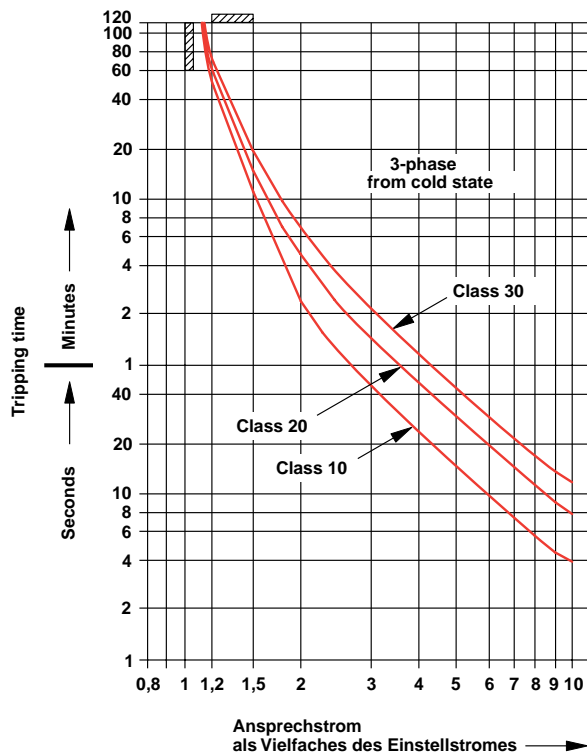

Annotation: Not suitable for single-phase and direct current (DC) motors!

Electronic overload relays E 16 DU

for contactors and mini contactors

Technical data

Resistances and power losses

Setting range	Short-circuit protection (fuses, miniature circuit-breakers)				Resistance per phase at upper setting current Ω	Power loss per phase W
A ... A	gL/gG A					

Electronic overload relay E 16 DU

0.1 ... 0.32	1				0.97	0.1
0.3 ... 1.00	4				0.113	0.11
0.9 ... 2.70	10				0.014	0.1
2.0 ... 6.30	20				0.0024	0.1
5.7 ... 18.90	50				0.0008	0.29

Approvals and certificates

Approvals			Ships' classification societies			
		German National Standards Laboratory PTB Ex „e“ * Germany		LRS Great Britain		
UL USA	CSA Canada		GL Germany		BV France	DNV Norway
■	■	□	■	■	■	■
■	■	□	■	■	■	■
■	■	□	■	■	■	■
■	■	□	■	■	■	■
■	■	□	■	■	■	■

■ Normal version approved;
rating plates bear the test mark if mandatory

□ Submitted for approval

* Protection of intrinsically safe motors (EN 50019) class Ex "e" to DIN VDE 0165/02.91
(= Protection of intrinsically safe motors (EN 50019) of enclosure increased safety "e" in accordance with the provisions for "Installation of electrical systems in explosion-hazard areas" to DIN VDE 0165/02.91.)

Thermal /electronic overload relays

Accessories

Dimensions

TA 25 DU

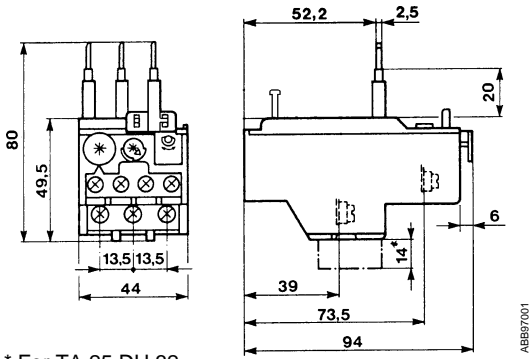

* For TA 25 DU 32

E16 DU

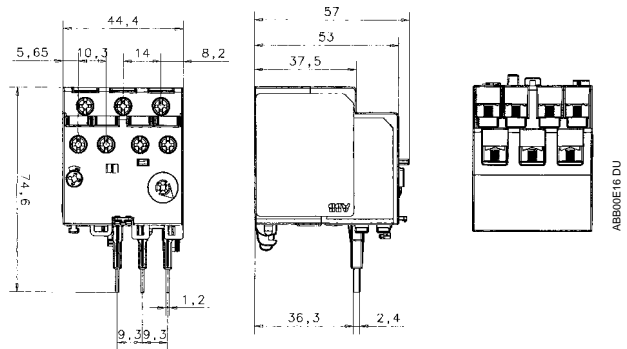

TA 25 DU + DB 25

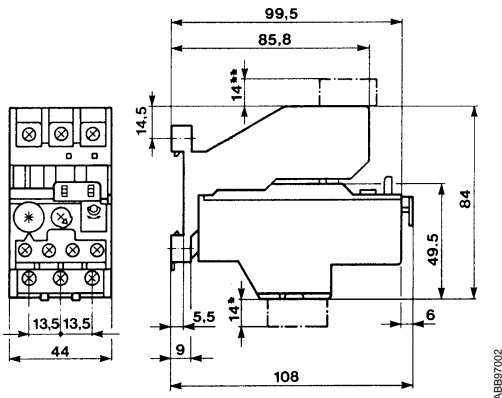

* For TA 25 DU 32

** For DB 25/32 A mounting kit for single set-up

E 16 DU + DB 16 E

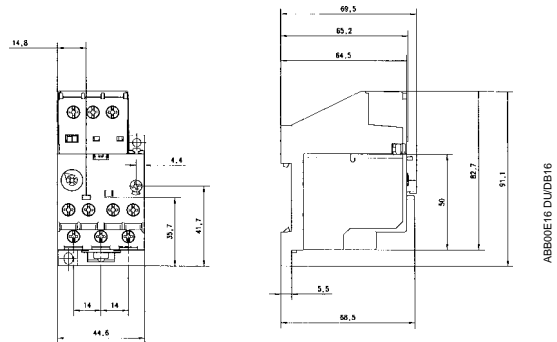

TA 25 DU + DS 25-A

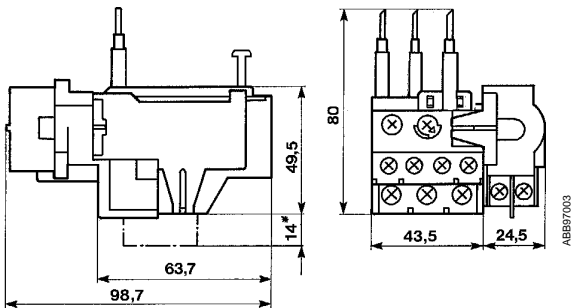

* For TA 25 DU 32

Drilling plan

(TA 25 DU + DB 25/25 A oder DB 25/32 A for single set-ups)

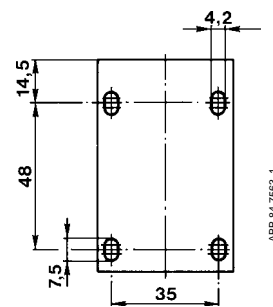

TA 42 DU

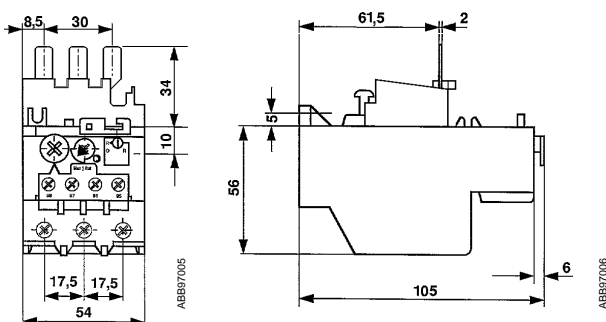

TA 25 DU + DR 25-A

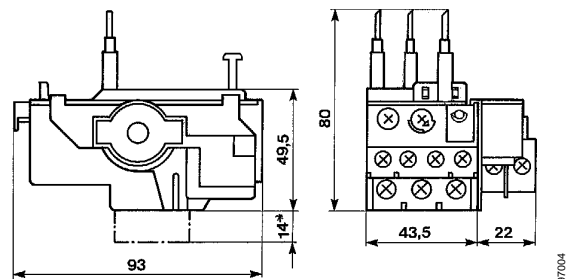

* For TA 25 DU 32

Thermal overload relays

Accessories

Dimensions

TA 75 DU

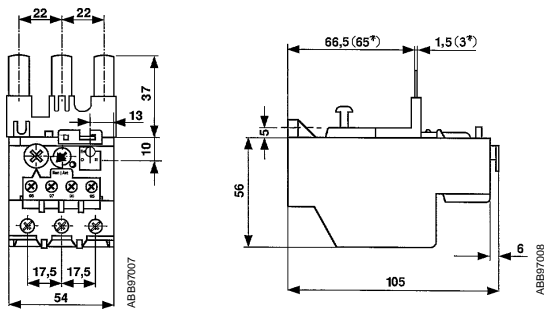

TA 80 DU

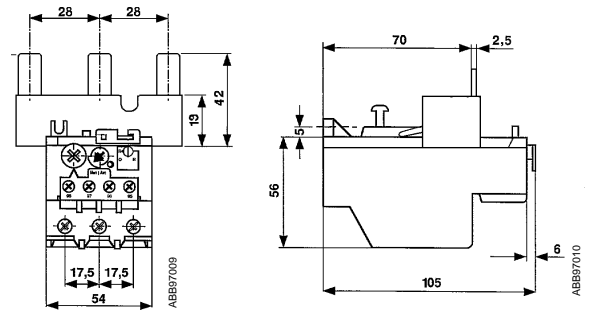

* For TA 75 DU 80

TA 42 DU, TA 75 DU, TA 80 DU + DB 80

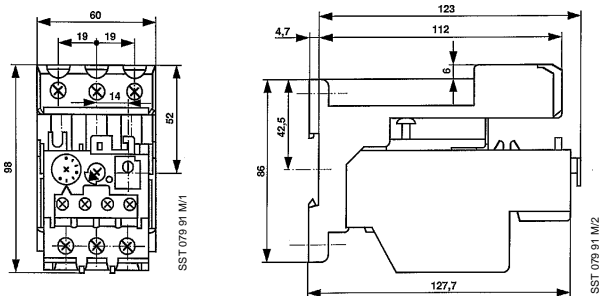

Drilling plan

(TA 42 DU, TA 75 DU und TA 80 DU + DB 80 for single set-up)

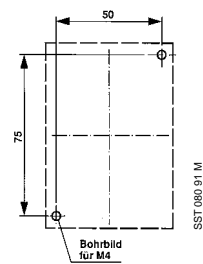

TA 110 DU

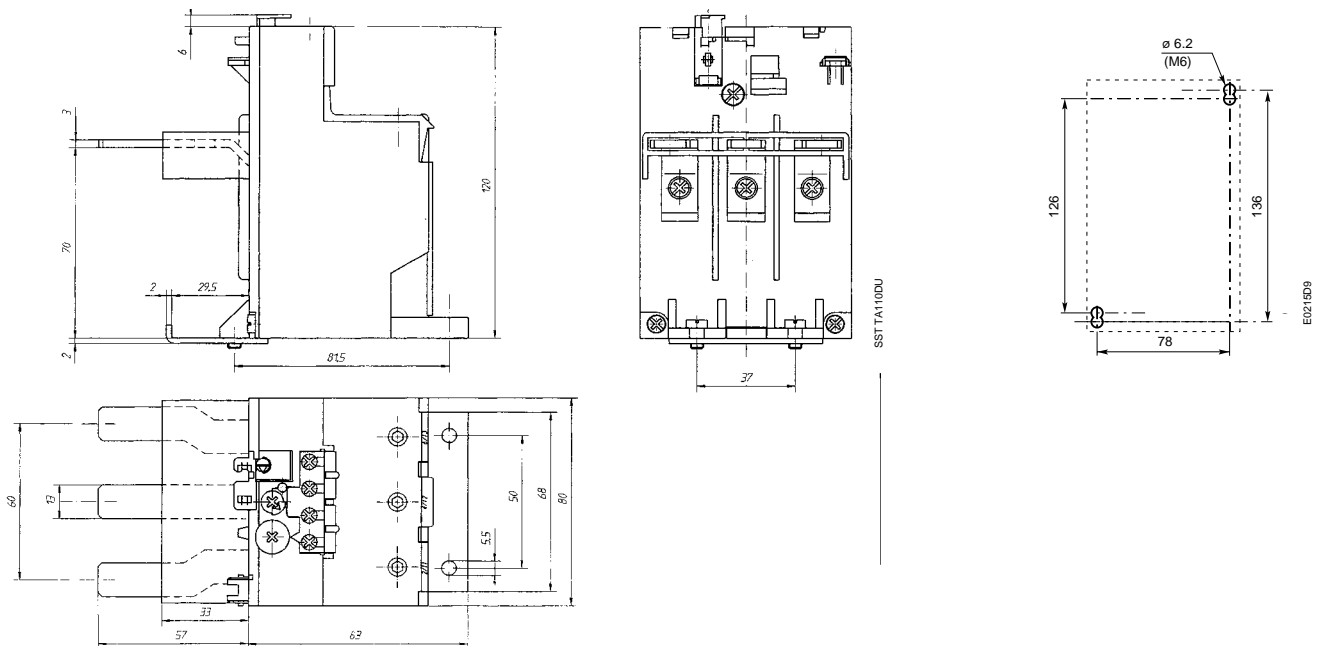

Thermal overload relays

Accessories

Dimensions

T / TA 200 DU

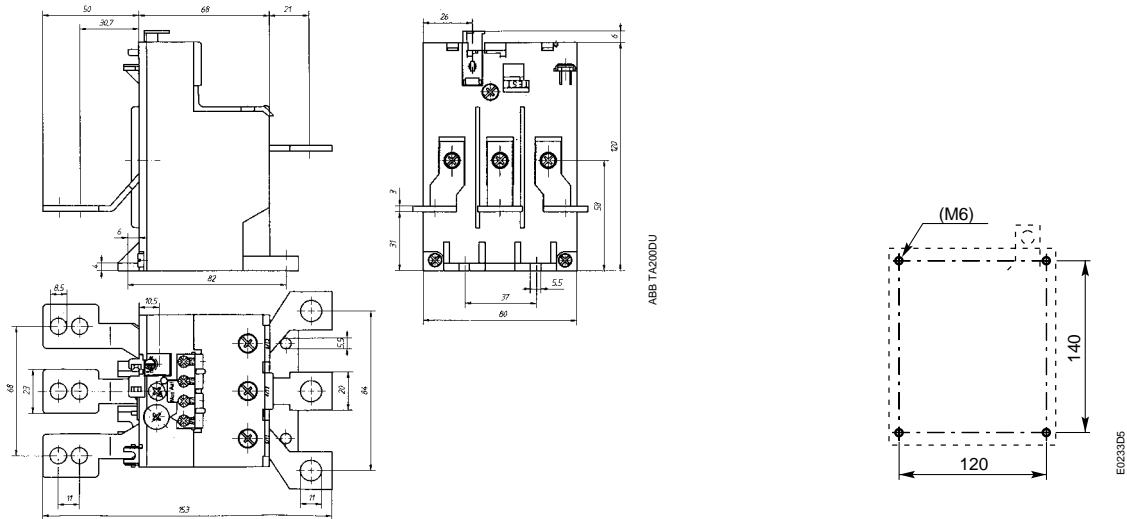

T / TA 450 DU/SU

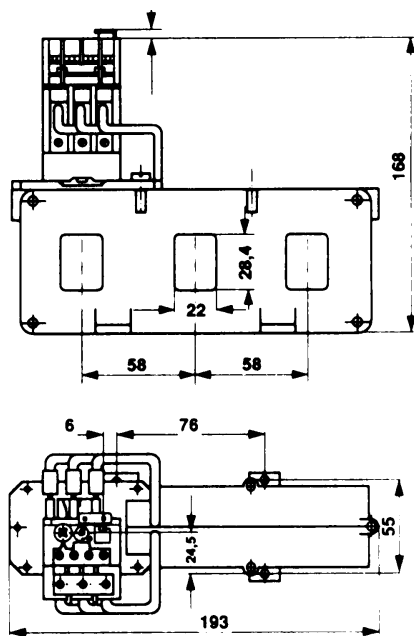

T 900 DU/SU

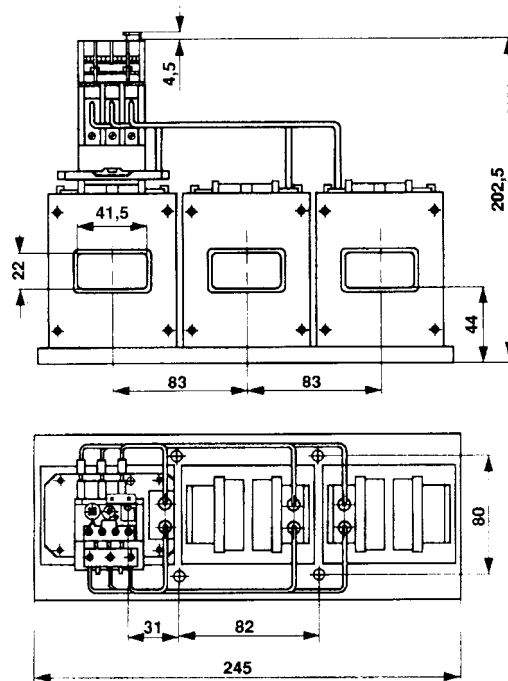

(dimensions in mm)

Electronic overload relays

Accessories

Dimensions

E 200 DU

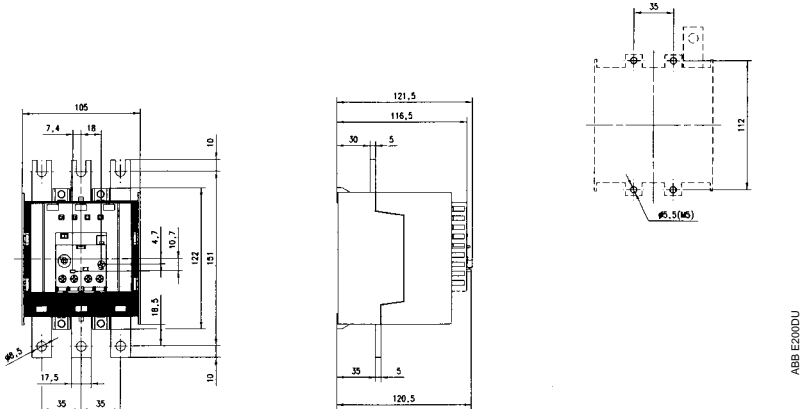

E 320 DU

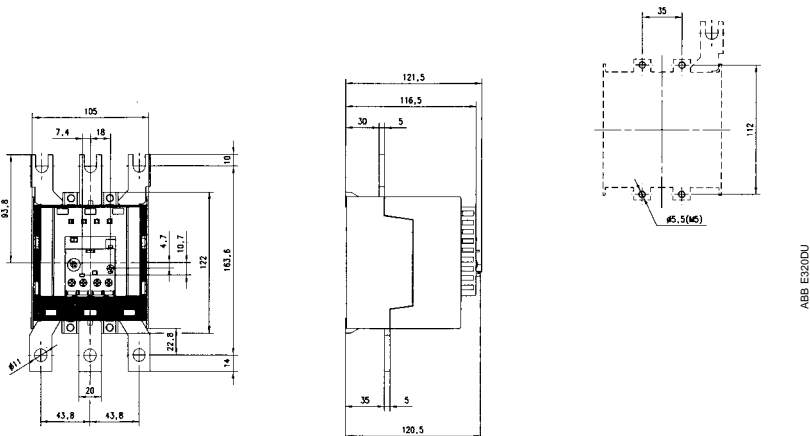

E 500 DU

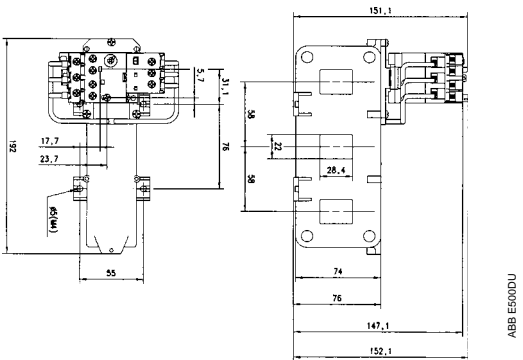

E 800 DU

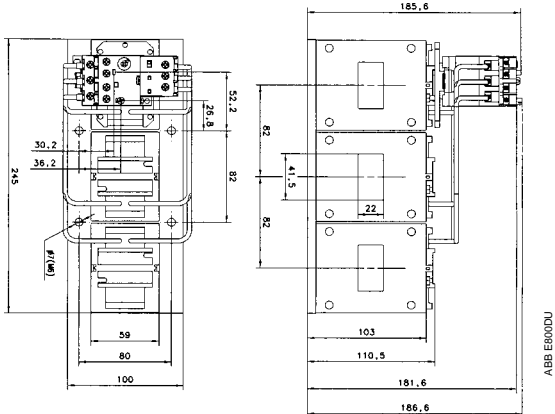

(dimensions in mm)



ABB STOTZ-KONTAKT GmbH
P.O.BOX 101680
D-69006 Heidelberg
Telephone ++49 62 21 / 7 01-00
Telefax ++49 62 21 / 7 01-1115
Internet <http://www.abb.de/sst>